

# Buck Regulator 3 A, Constant On Time (COT)

## FAN53730



WLCSP12 1.07 x 1.36 x 0.432, 0.35P  
CASE 567GK

### Description

The FAN53730 is a constant on time (COT) buck converter that supports a minimum of 3 A load current. The device's COT topology provides the fastest transient recovery and optimal efficiency vs load due to its variable frequency operation.

Two device options are available (see [Ordering Information](#)):

- ◆ I<sup>2</sup>C Controlled
- ◆ Logic Controlled (pin selectable V<sub>OUT</sub>)

Both options have automatic DCM/CCM mode operation with Forced CCM control.

### Features

- Input Voltage Range: 2.3 V to 5.5 V
- Output Voltage:
  - ◆ Programmable from 0.3 V to 2 V
  - ◆ Pin Selectable Defaults
- Low Quiescent Current: 12  $\mu$ A
- Internal Soft-Start Limits Input Current During Turn-On
- 2.5 MHz Switching Frequency in Continuous Conduction Operation
- 1.2 V and 1.8 V Logic Compatible
- Fault Protection (Input Under Voltage, Short Circuit, Over Current, and Thermal)
- Power Good Output (PG)
- Forced Continuous Conduction Mode (FCCM)
- Audio Reduction Mode Eliminates Audible Tones Due to Switching
- -40°C to +85°C Ambient Temperature Range
- This is a Pb-Free Device

### Applications

- LPDDR Memory
- Mobile and Smart Devices
- RF Modules

### MARKING DIAGRAM



- XX = Specific Device Code
- ZZ = Assembly Lot
- A = Site Code
- Y = Year
- WW = 2 Digit Work Week

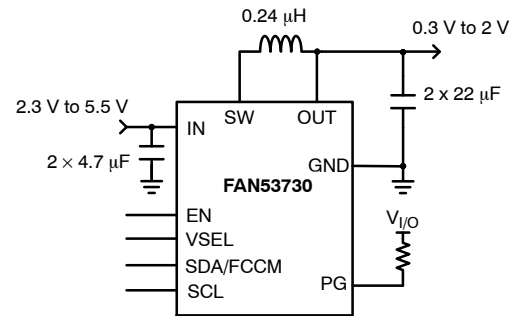

Figure 1. Typical Application Circuit

### ORDERING INFORMATION

See detailed ordering and shipping information on page 2 of this data sheet.

# FAN53730

## ORDERING INFORMATION

Part Number	Device Option	Default VSEL	I <sup>2</sup> C Address	Ambient Temperature Range	Package	Shipping <sup>†</sup>	Specific Device Code
FAN53730UCX	I <sup>2</sup> C Controlled	VSET1 = 1.00 V VSET2 = 1.05 V	7 h'20	-40°C to 85°C	1.07 mm × 1.36 mm, 0.35 mm pitch, 12-bump WLCSP	3000 / Tape & Reel	MH
FAN53730UC01X	I <sup>2</sup> C Controlled	VSET1 = 1.00 V VSET2 = 1.05 V	7 h'22			3000 / Tape & Reel	WE
FAN53730UC02X	I <sup>2</sup> C Controlled	VSET1 = 1.00 V VSET2 = 1.05 V	7 h'30			3000 / Tape & Reel	WF
TBD	Logic Controlled	VSET1 = TBD VSET2 = TBD	Not Applicable			TBD / Tape & Reel	TBD

<sup>†</sup>For information on tape and reel specifications, including part orientation and tape sizes, please refer to our Tape and Reel Packaging Specifications Brochure, [BRD8011/D](#).

NOTE: Additional options available upon request.

## PIN CONFIGURATION

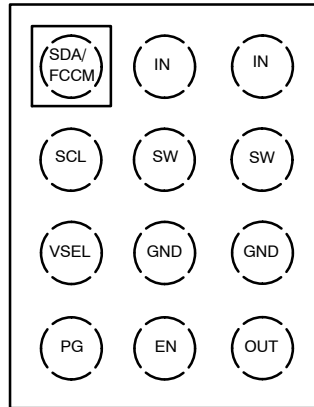

Figure 2. Bumps Facing Down

## PIN DEFINITIONS

Pin #	Name	Description
A1	SDA/FCCM	SDA I/O in I <sup>2</sup> C controlled device. In the logic controlled device this pin is the FCCM control. Connect to V <sub>IN</sub> to force continuous conduction at all loads. Connect to GND for variable frequency operation.
A2, A3	IN	Input voltage connection. Connect to a 2.3 V to 5.5 V input supply.
B1	SCL	SCL input in I <sup>2</sup> C controlled device. In the logic controlled device this pin is unused and should connect to GND.
B2, B3	SW	Device switching node. Connect to inductor.
C1	VSEL	Voltage select input. Drive VSEL low to select VSET1. Drive VSEL high to select VSET2.
C2, C3	GND	Ground connection
D1	PG	Power good output. PG goes open drain when V <sub>OUT</sub> is in regulation (I <sup>2</sup> C device can change polarity of PG).
D2	EN	Device logic high enable input. Drive EN high to enable the device. I <sup>2</sup> C bus remains active when EN is low.
D3	OUT	Output voltage sense input. Connect to positive terminal of output capacitor.

# FAN53730

## BLOCK DIAGRAM

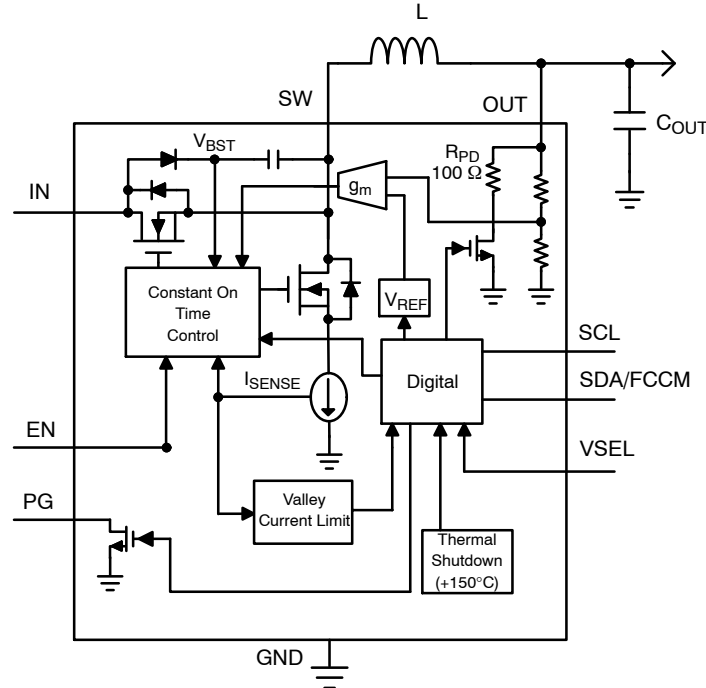

Figure 3. Simplified Block Diagram

### MAXIMUM RATINGS

Symbol	Parameter	Condition	Min	Typ	Max	Unit
$V_{IN}$	Input Voltage		-0.3	-	6.0	V
$V_{SW}$	Voltage on SW Pin		-0.3	-	$V_{IN} + 0.3$	V
$V_{OUT}$	Output Voltage		-0.3	-	$V_{IN} + 0.3$	V
$V_{EN}$	Enable Input Voltage		-0.3	-	$V_{IN} + 0.3$	V
$V_{SCL}, V_{SDA/FCCM}$	SCL, SDA/FCCM Voltage		-0.3	-	$V_{IN} + 0.3$	V
$V_{SEL}$	Voltage Select Input voltage		-0.3	-	$V_{IN} + 0.3$	V
$V_{PG}$	Power Good Output Voltage		-0.3	-	$V_{IN} + 0.3$	V
ESD	Electrostatic Discharge Protection Level	Human Body Model	-	2.0	-	kV
		Charged Device Model	-	1000	-	V
$T_J$	Junction Temperature		-40	-	+150	°C
$T_{STG}$	Storage Temperature		-65	-	+150	°C
$T_L$	Soldering Temperature (10 Seconds)		-	-	+260	°C

Stresses exceeding those listed in the Maximum Ratings table may damage the device. If any of these limits are exceeded, device functionality should not be assumed, damage may occur and reliability may be affected.

### THERMAL PROPERTIES

Thermal resistance is a function of application and board layout. Theta JA is based on a 2s2p with and without via-in-pad center bump vias in accordance to JEDEC standard JESD51. Special attention must be paid not to exceed junction temperature  $T_J(\max)$  at a given ambient temperature  $T_A$ .

Symbol	Parameter	Conditions	Min	Typ	Max	Unit
$\theta_{JA}$	Junction-to-Ambient Thermal Resistance	2S2P w/o via-in-pad PCB @ 0.5 W Dissipation	-	130	-	°C/W
$\theta_{JA}$	Junction-to-Board Thermal Resistance	2S2P with via-in-pad PCB @ 0.5 W Dissipation	-	50	-	°C/W

# FAN53730

## RECOMMENDED OPERATING CONDITIONS

Symbol	Parameter	Conditions	Min	Typ	Max	Unit
V <sub>IN</sub>	Input Voltage Range		2.3	–	5.5	V
V <sub>OUT</sub>	Output Voltage Range		0.3	–	2	V
L	Inductor (Nominal Value)		–20%	0.24	+20%	μH
C <sub>IN</sub>	Input Capacitor		–	4.7	–	μF
C <sub>OUT</sub>	Output Capacitor (Typical Derated Value)	C <sub>OUT</sub> = 2 × 22 μF (0402), V <sub>OUT</sub> = 1 V, DC bias derated	–20%	36	–	μF
T <sub>A</sub>	Ambient Temperature Range		–40	–	+85	°C
T <sub>J</sub>	Junction Temperature		–40	–	+125	°C

Functional operation above the stresses listed in the Recommended Operating Ranges is not implied. Extended exposure to stresses beyond the Recommended Operating Ranges limits may affect device reliability.

## ELECTRICAL CHARACTERISTICS

Minimum and maximum values are at 2.3 V ≤ V<sub>IN</sub> ≤ 5.5 V, 0.3 V ≤ V<sub>OUT</sub> ≤ 2 V, –40°C ≤ T<sub>A</sub> ≤ +85°C unless otherwise noted. Typical values are at T<sub>A</sub> = 25°C, V<sub>IN</sub> = 3.8 V, V<sub>OUT</sub> = 1.0 V (Note 1, Note 2)

Symbol	Parameter	Test Condition	Min	Typ	Max	Unit
--------	-----------	----------------	-----	-----	-----	------

### GENERAL

R <sub>PD</sub>	Output Discharge Resistance	EN = Low	72	93	131	Ω
I <sub>OUT_SENSE</sub>	OUT Sense Input Leakage Current	V <sub>OUT</sub> = 1 V	–	–	1	μA
T <sub>SD</sub>	Thermal Shutdown	Die Temperature Rising	–	150	–	°C
T <sub>SD_HYST</sub>	Thermal Shutdown Hysteresis		–	30	–	°C
f <sub>CLK</sub>	Fault Clock Frequency		450	500	550	kHz
R <sub>EN</sub>	Enable Input Pull–Down Resistance	V <sub>IN</sub> = 3.8 V	–	300	–	kΩ
R <sub>PG</sub>	PG Output Pull–down		–	–	133	Ω
V <sub>PG_TH</sub>	V <sub>OUT</sub> Rising Threshold for PG Going Open Drain, PG_POL = 1	V <sub>OUT</sub> = 0.3 V	–	93	–	%
I <sub>PG_POL</sub>	PG Leakage Current	EN = Low, V <sub>PG</sub> = 5.5 V	–	0.01	–	μA
I <sub>EN_L</sub>	EN Input Leakage Current	EN = 5.5 V	–	0.01	–	μA
V <sub>IH</sub>	Logic High Voltage (VSEL, EN, FCCM)		0.825	–	–	V
V <sub>IL</sub>	Logic Low Voltage (VSEL, EN, FCCM)		–	–	0.4	V

### V<sub>OUT</sub> ACCURACY

V <sub>OUT_ACC</sub>	Output Voltage Accuracy	V <sub>OUT</sub> < 1 V, No Load, V <sub>IN</sub> ≥ V <sub>OUT</sub> + 1.5 V	–20	–	9	mV
		V <sub>OUT</sub> ≥ 1 V, No Load, V <sub>IN</sub> ≥ V <sub>OUT</sub> + 1.5 V	–16	–	12	mV
		V <sub>OUT</sub> < 1 V, FCCM, No Load, V <sub>IN</sub> ≥ V <sub>OUT</sub> + 1.5 V	–14	–	13	mV
		V <sub>OUT</sub> ≥ 1 V, FCCM, No Load, V <sub>IN</sub> ≥ V <sub>OUT</sub> + 1.5 V	–1	–	1.1	%

### OPERATING CURRENT

I <sub>SHDN</sub>	Shutdown Supply Current	I <sup>2</sup> C Controlled device, EN = Low, SDA = SCL = 1.2 V	–	1.5	3.5	μA
I <sub>SHDN</sub>	Shutdown Supply Current	Logic Controlled device, EN = Low	–	1.5	3.5	μA
I <sub>Q_ACTIVE</sub>	Active Supply Current	V <sub>OUT</sub> = 1 V, EN = High, No Load, No Switching	–	12.8	19.3	μA

### CURRENT LIMIT

I <sub>VALLEY</sub>	Valley Current Limit	V <sub>OUT</sub> = 1 V, [VAL_ILIM] = 1	3.5	4.2	4.8	A
I <sub>VALLEY</sub>	Valley Current Limit	V <sub>OUT</sub> = 1 V, [VAL_ILIM] = 0	1.9	2.3	2.6	A
I <sub>LIM_NEG</sub>	Negative Current limit		–	1.5	–	A
t <sub>SHORT</sub>	Short–Circuit Timeout	V <sub>OUT</sub> < 0.1 V (Note 3)	–	40	–	μs
V <sub>SHORT</sub>	Output Short Circuit Threshold	t < t <sub>SHORT</sub>	68	140	212	mV

# FAN53730

## ELECTRICAL CHARACTERISTICS (continued)

Minimum and maximum values are at  $2.3\text{ V} \leq V_{IN} \leq 5.5\text{ V}$ ,  $0.3\text{ V} \leq V_{OUT} \leq 2\text{ V}$ ,  $-40^\circ\text{C} \leq T_A \leq +85^\circ\text{C}$  unless otherwise noted. Typical values are at  $T_A = 25^\circ\text{C}$ ,  $V_{IN} = 3.8\text{ V}$ ,  $V_{OUT} = 1.0\text{ V}$  (Note 1, Note 2)

Symbol	Parameter	Test Condition	Min	Typ	Max	Unit
--------	-----------	----------------	-----	-----	-----	------

### SWITCH ON TIME

$t_{ON}$	High side switch on-time	$V_{IN} = 2.3\text{ V}$ , $V_{OUT} = 1\text{ V}$	181	196	202	ns
$t_{ON}$	High side switch on-time	$V_{IN} = 3.8\text{ V}$ , $V_{OUT} = 1\text{ V}$	104	113	116	ns
$t_{ON}$	High side switch on-time	$V_{IN} = 5.5\text{ V}$ , $V_{OUT} = 1\text{ V}$	70	78	80	ns

### UVLO DETECTION

$V_{UVLO\_R}$	Under-Voltage Lockout Threshold	Rising $V_{IN}$	-	-	2.3	V
$V_{UVLO\_F}$	Under-Voltage Lockout Threshold	Falling $V_{IN}$	2.1	-	-	V
$V_{UVLO\_H}$	UVLO Hysteresis		-	100	-	mV

### POWER MOSFETs RDSON

$R_{DS_{ON\_LOW}}$	Low Side NMOS Resistance (Ball-to-Ball)	$V_{IN} = V_{GS} = 3.8\text{ V}$	-	23	-	m $\Omega$
$R_{DS_{ON\_HIGH}}$	High Side NMOS Resistance (Ball-to-Ball)	$V_{IN} = V_{GS} = 3.8\text{ V}$	-	33	-	m $\Omega$

### AUDIO MODE

$R_{AUDIO}$	Pull-down FET for Output Discharge	$V_{IN} = 3.8\text{ V}$	-	5	-	$\Omega$
$t_{AUDIO}$	Maximum Dead Time in Audio Mode	$[ARM\_TO] = 0$	-	25	-	$\mu\text{s}$
$t_{AUDIO}$	Maximum Dead Time in Audio Mode	$[ARM\_TO] = 1$	-	40	-	$\mu\text{s}$

### I<sup>2</sup>C TIMING AND PERFORMANCE – FOR I<sup>2</sup>C VERSION (Note 4)

$V_{IL}$	SDA and SCL Logic Low threshold		-	-	0.4	V
$V_{IH}$	SDA and SCL Logic High threshold		0.825	-	5.5	V
$V_{OL}$	SDA Logic Low Output	3 mA sink	-	-	0.4	V
$f_{SCL}$	SCL Clock Frequency	Fast Mode Plus	-	-	1000	kHz
$t_{BUF}$	Bus-Free Time Between STOP and START Conditions	Fast Mode Plus	0.5	-	-	$\mu\text{s}$
$t_{HD; STA}$	START or Repeated START Hold Time	Fast Mode Plus	260	-	-	ns
$t_{LOW}$	SCL LOW Period	Fast Mode Plus	0.5	-	-	$\mu\text{s}$
$t_{HIGH}$	SCL HIGH Period	Fast Mode Plus	260	-	-	ns
$t_R$	SDA and SCL Rise Time	Fast Mode Plus	-	-	120	ns
$t_F$	SDA and SCL Fall Time	Fast Mode Plus, $V_{DD} = 1.8\text{ V}$	6.55	-	120	ns
$t_{SU; STO}$	Stop Condition Setup Time	Fast Mode Plus	260	-	-	ns
$C_I$	SDA and SCL Input Capacitance		-	-	10	pF

Product parametric performance is indicated in the Electrical Characteristics for the listed test conditions, unless otherwise noted. Product performance may not be indicated by the Electrical Characteristics if operated under different conditions.

1. Refer to Typical Characteristics waveforms/graphs for closed loop data and variation with input supply and temperature.
2. Electrical Characteristics reflects open loop steady state data. System Characteristics reflects both steady state and dynamic close loop data associated with the recommended external components.
3. Short-Circuit timeout is the time after  $V_{OUT}$  falls below  $V_{SHORT}$  to when the FAN53730 is placed into the Fault state.
4. Guaranteed by Design. Characterized on the ATE or Bench.

# FAN53730

## SYSTEM CHARACTERISTICS

The following system specifications are guaranteed by designed and verified during bench evaluation, but are not performed in production testing. Recommended operating conditions, unless otherwise noted are  $2.3\text{ V} \leq V_{IN} \leq 5.5\text{ V}$ ,  $0.3\text{ V} \leq V_{OUT} \leq 2\text{ V}$ ,  $V_{IN} = V_{OUT} + 1.5\text{ V}$ ,  $-40^\circ\text{C} \leq T_A \leq 85^\circ\text{C}$ . Typical values are based on  $V_{IN} = 3.8\text{ V}$ ,  $V_{OUT} = 1.0\text{ V}$  and  $T_A = 25^\circ\text{C}$ . System Specifications are based on the Typical Application Circuit,  $L = 0.24\text{ }\mu\text{H}$ ,  $C_{IN} = 10\text{ }\mu\text{F}$ ,  $C_{OUT} = 2 \times 22\text{ }\mu\text{F}$  (nominal)

Symbol	Parameter	Test Condition	Min	Typ	Max	Unit
--------	-----------	----------------	-----	-----	-----	------

### GENERAL

IQ <sub>IN_DCM</sub>	DCM Quiescent Current	EN = High, $2.3\text{ V} \leq V_{IN} \leq 5.5\text{ V}$ , $V_{OUT} = 1\text{ V}$ , [BIAS_MODE] = 00, No Load	-	12.8	19.3	$\mu\text{A}$
		EN = High, [BIAS_MODE] = 1X, No Load	-	262	-	$\mu\text{A}$
IQ <sub>CCM</sub>	CCM Quiescent Current	EN = High, FCCM, No Load	-	13.9	-	mA
t <sub>ss</sub>	Soft-Start	From EN High to 95% of V <sub>OUT</sub> Target, No Load, [RR_DVS] = 001	-	800	-	$\mu\text{s}$

### EFFICIENCY

eff	Efficiency	I <sub>OUT</sub> = 1 mA, V <sub>OUT</sub> = 1.0 V, V <sub>IN</sub> = 3.8 V	-	82.1	-	%
eff	Efficiency	I <sub>OUT</sub> = 10 mA, V <sub>OUT</sub> = 1.0 V, V <sub>IN</sub> = 3.8 V	-	86.8	-	%
eff	Efficiency	I <sub>OUT</sub> = 100 mA, V <sub>OUT</sub> = 1.0 V, V <sub>IN</sub> = 3.8 V	-	87.5	-	%
eff	Efficiency	I <sub>OUT</sub> = 500 mA, V <sub>OUT</sub> = 1.0 V, V <sub>IN</sub> = 3.8 V	-	88.2	-	%
eff	Efficiency	I <sub>OUT</sub> = 1000 mA, V <sub>OUT</sub> = 1.0 V, V <sub>IN</sub> = 3.8 V	-	89.3	-	%
eff	Efficiency	I <sub>OUT</sub> = 3000 mA, V <sub>OUT</sub> = 1.0 V, V <sub>IN</sub> = 3.8 V	-	83	-	%

### I<sub>OUT</sub> MAX

I <sub>OUT_MAX</sub>	Maximum Output Current (Note 6)	V <sub>IN</sub> from 2.5 V to 5.5 V, V <sub>OUT</sub> from 0.3 V to 1 V	3	-	-	A
----------------------	---------------------------------	---	---	---	---	---

### V<sub>OUT</sub> LOAD REGULATION

V <sub>LO_REG</sub>	Load Regulation	I <sub>OUT</sub> = 10 $\mu\text{A}$ to 3 A, V <sub>IN</sub> = 2.5 V to 5.5 V, V <sub>OUT</sub> = 1 V, [BIAS_MODE] = 00	-	-	0.6	%/A
V <sub>LO_REG</sub>	Load Regulation	I <sub>OUT</sub> = 10 $\mu\text{A}$ to 3 A, V <sub>IN</sub> = 2.5 V to 5.5 V, V <sub>OUT</sub> = 1 V, [BIAS_MODE] = 1X	-	-	0.4	%/A
V <sub>LO_REG</sub>	Load Regulation (CCM)	I <sub>OUT</sub> = 10 $\mu\text{A}$ to 3 A, V <sub>IN</sub> = 2.5 V to 5.5 V, V <sub>OUT</sub> = 1 V, FCCM	-	-	0.4	%/A

### V<sub>OUT</sub> LINE REGULATION

V <sub>LREG_CCM</sub>	Line Regulation 10 $\mu\text{A}$	I <sub>OUT</sub> = 10 $\mu\text{A}$ , V <sub>OUT</sub> = 1 V, V <sub>IN</sub> = 2.5 V to 5.5 V	-	-	0.12	%/V
V <sub>LREG_DCM</sub>	Line Regulation 10 mA	I <sub>OUT</sub> = 10 mA, V <sub>OUT</sub> = 1 V, V <sub>IN</sub> = 2.5 V to 5.5 V	-	-	0.08	%/V
V <sub>LREG_DCM</sub>	Line Regulation 3 A	I <sub>OUT</sub> = 3 A, V <sub>OUT</sub> = 1 V, V <sub>IN</sub> = 2.5 V to 5.5 V	-	-	0.08	%/V

### SWITCHING

V <sub>RIPPLE_DCM</sub>	Output Ripple	V <sub>IN</sub> = 2.3 V to 5.5 V, I <sub>OUT</sub> = 10 mA, FCCM, V <sub>OUT</sub> = 1 V	-	12	-	mVpp
V <sub>RIPPLE_CCM</sub>	Output Ripple	V <sub>IN</sub> = 2.3 V to 5.5 V, I <sub>OUT</sub> = 3 A, V <sub>OUT</sub> = 1 V	-	6	-	mVpp
f <sub>CCM</sub>	Switching Frequency in CCM Mode	I <sub>OUT</sub> = 1 A, FCCM	-	2.5	-	MHz

## FAN53730

### SYSTEM CHARACTERISTICS (continued)

The following system specifications are guaranteed by designed and verified during bench evaluation, but are not performed in production testing. Recommended operating conditions, unless otherwise noted are  $2.3\text{ V} \leq V_{IN} \leq 5.5\text{ V}$ ,  $0.3\text{ V} \leq V_{OUT} \leq 2\text{ V}$ ,  $V_{IN} = V_{OUT} + 1.5\text{ V}$ ,  $-40^\circ\text{C} \leq T_A \leq 85^\circ\text{C}$ . Typical values are based on  $V_{IN} = 3.8\text{ V}$ ,  $V_{OUT} = 1.0\text{ V}$  and  $T_A = 25^\circ\text{C}$ . System Specifications are based on the Typical Application Circuit,  $L = 0.24\ \mu\text{H}$ ,  $C_{IN} = 10\ \mu\text{F}$ ,  $C_{OUT} = 2 \times 22\ \mu\text{F}$  (nominal)

Symbol	Parameter	Test Condition	Min	Typ	Max	Unit
--------	-----------	----------------	-----	-----	-----	------

#### CURRENT LIMIT

I <sub>VALLEY_CL</sub>	Closed Loop Valley Current Limit (Note 5)	$V_{IN} \geq 2.5\text{ V}$ , [VAL_ILIM] = 1	–	4.6	–	A
		$V_{IN} \geq 2.5\text{ V}$ , [VAL_ILIM] = 0	–	2.3	–	A
		$V_{IN} = 2.3\text{ V}$ , [VAL_ILIM] = 1	–	2.8	–	A
		$V_{IN} = 2.3\text{ V}$ , [VAL_ILIM] = 0	–	1.8	–	A

5. Closed loop current limit reflects the maximum control loop error amplifier voltage output, which can mean that the inductor valley current limit has reached its maximum value, or that the control loop has reached a maximum duty cycle.
6. Refer to Fig. 19 Typical Derating Curve for additional I<sub>OUT(MAX)</sub> guidance.

TYPICAL CHARACTERISTICS

Unless otherwise specified  $V_{IN} = 3.8\text{ V}$ ,  $V_{OUT} = 1\text{ V}$ ,  $T_A = 25^\circ\text{C}$ , Circuit of Figure 34 and components from [Applications Circuit Components Table](#).

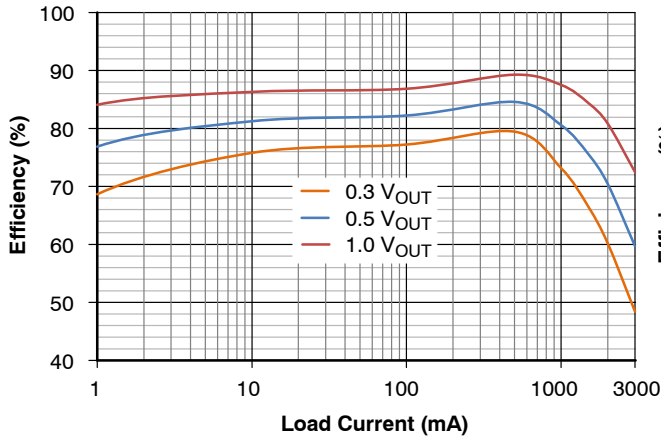

Figure 4. Efficiency vs.  $I_{OUT}$ ,  $V_{IN} = 2.5\text{ V}$

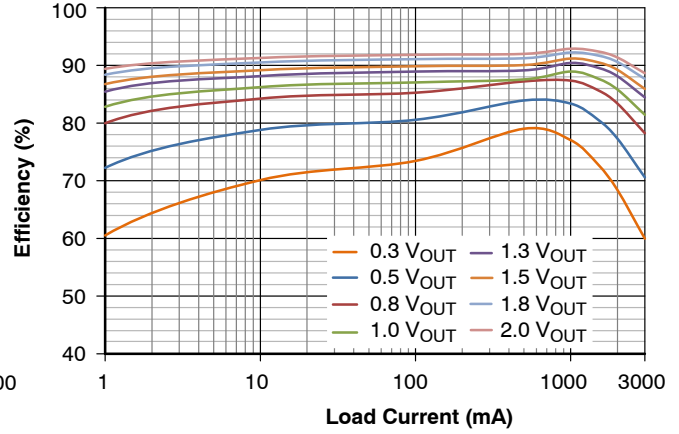

Figure 5. Efficiency vs.  $I_{OUT}$ ,  $V_{IN} = 3.8\text{ V}$

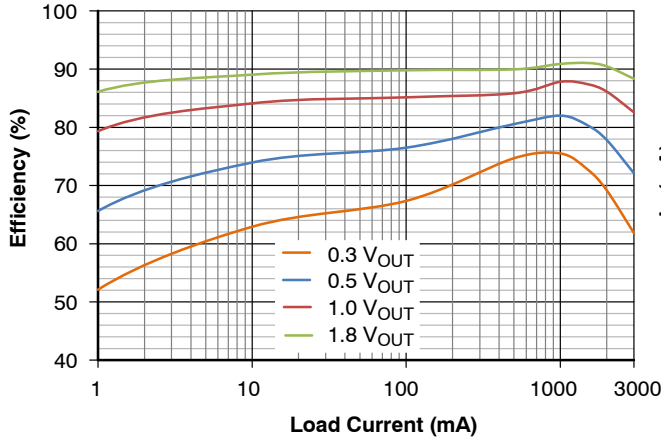

Figure 6. Efficiency vs.  $I_{OUT}$ ,  $V_{IN} = 5.0\text{ V}$

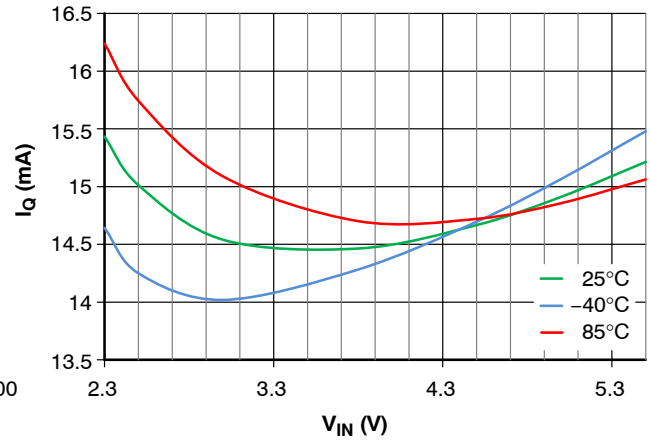

Figure 7. Quiescent Current (FCCM) vs.  $V_{IN}$

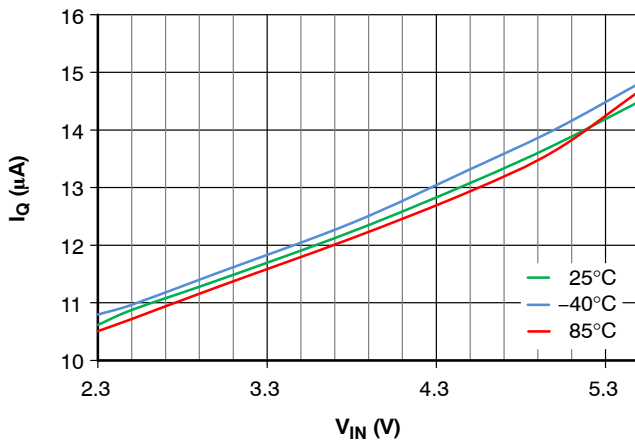

Figure 8. Quiescent Current (DCM) vs.  $V_{IN}$ ,  $[BIAS\_MODE] = 00$

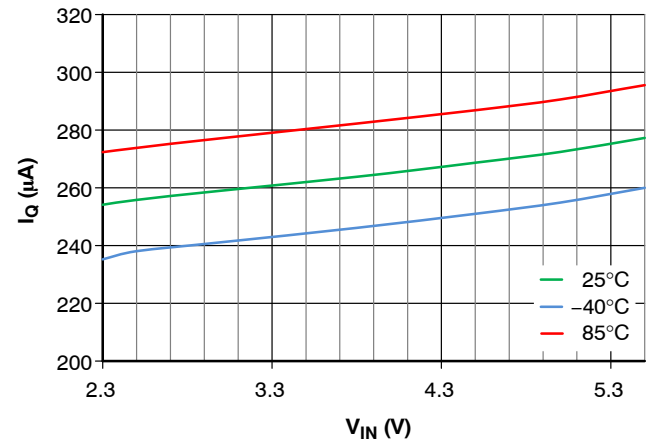

Figure 9. Quiescent Current (DCM) vs.  $V_{IN}$ ,  $[BIAS\_MODE] = 1X$



TYPICAL CHARACTERISTICS (continued)

Unless otherwise specified  $V_{IN} = 3.8\text{ V}$ ,  $V_{OUT} = 1\text{ V}$ ,  $T_A = 25^\circ\text{C}$ , Circuit of Figure 34 and components from [Applications Circuit Components Table](#).

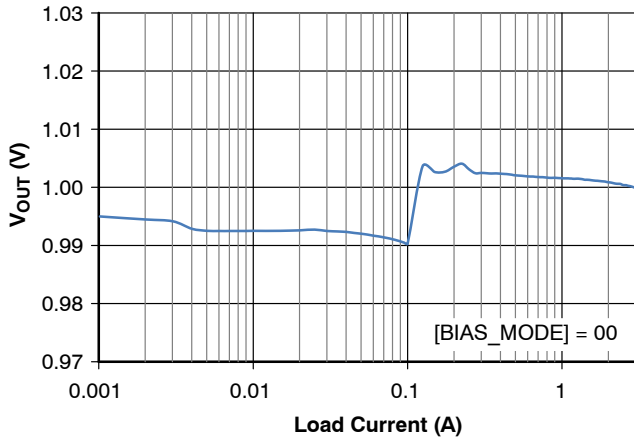

Figure 10. Load Regulation (DCM), [BIAS\_MODE] = 00

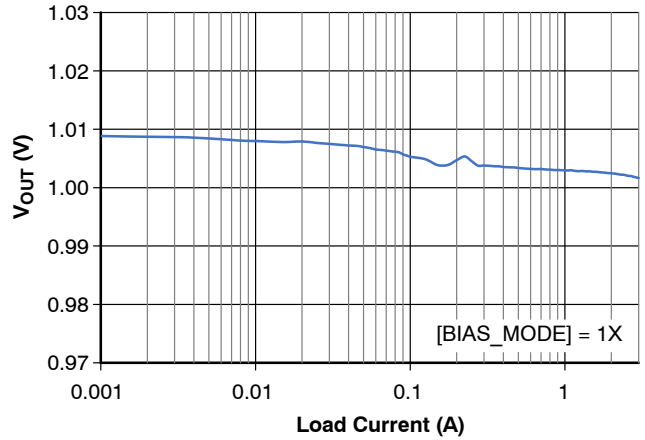

Figure 11. Load Regulation (DCM), [BIAS\_MODE] = 1X

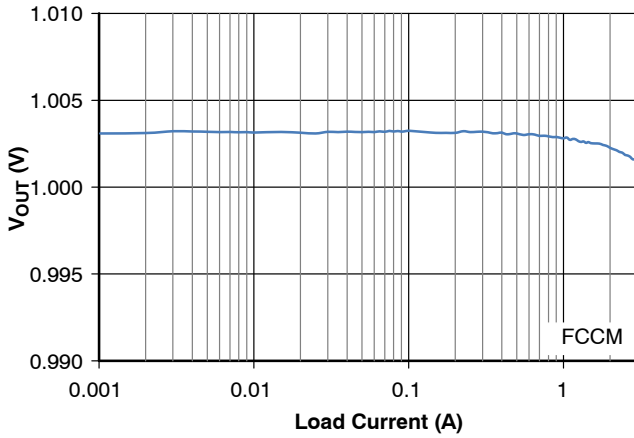

Figure 12. Load Regulation (FCCM)

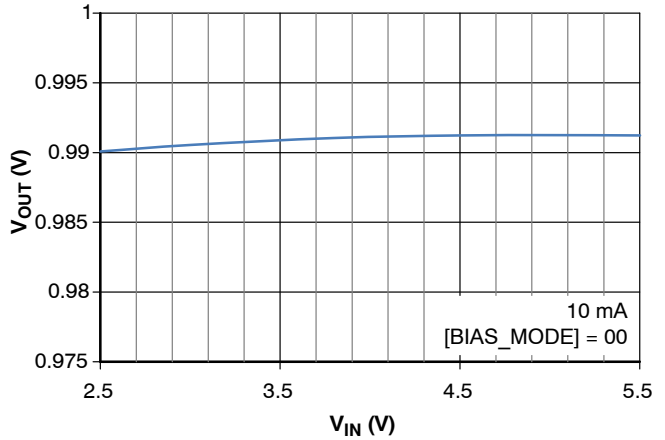

Figure 13. Line Regulation (DCM),  $I_{OUT} = 10\text{ mA}$ , [BIAS\_MODE] = 00

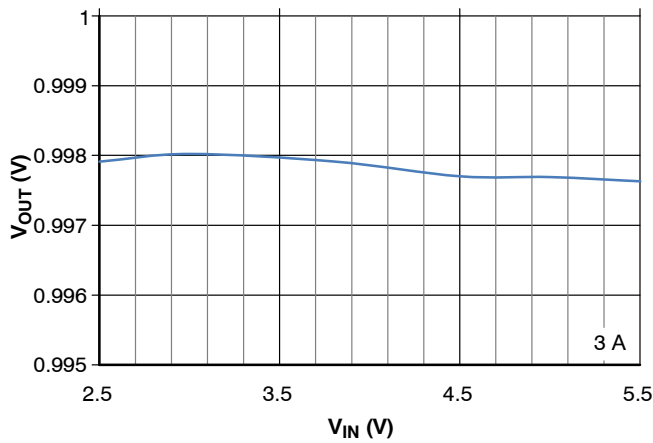

Figure 14. Line Regulation,  $I_{OUT} = 3\text{ A}$

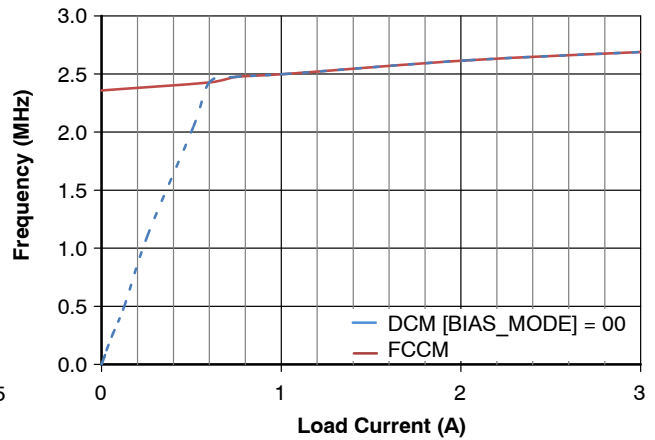

Figure 15. Switching Frequency vs.  $I_{OUT}$ , FCCM (Solid), DCM [BIAS\_MODE] = 00 (Dotted)

TYPICAL CHARACTERISTICS (continued)

Unless otherwise specified  $V_{IN} = 3.8\text{ V}$ ,  $V_{OUT} = 1\text{ V}$ ,  $T_A = 25^\circ\text{C}$ , Circuit of Figure 34 and components from [Applications Circuit Components Table](#).

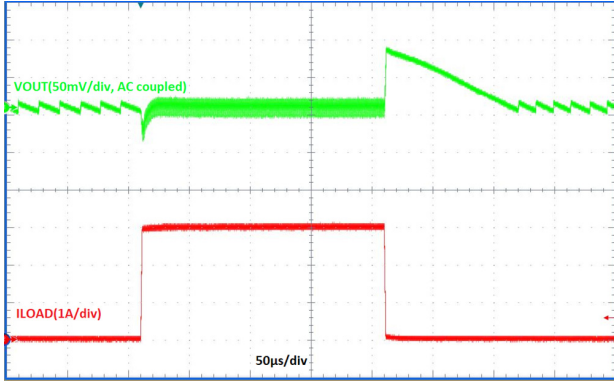

Figure 16. Load Transient (DCM),  $I_{OUT} = 10\text{ mA} \leftrightarrow 3\text{ A}$ ,  
Trise = Tfall =  $1\text{ }\mu\text{s}$

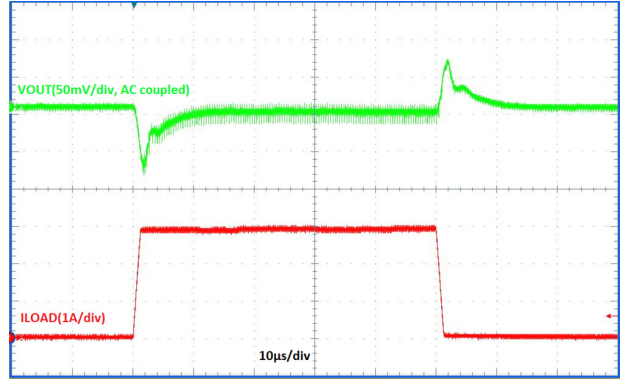

Figure 17. Load Transient (FCCM),  $I_{OUT} = 10\text{ mA} \leftrightarrow 3\text{ A}$ ,  
Trise = Tfall =  $1\text{ }\mu\text{s}$

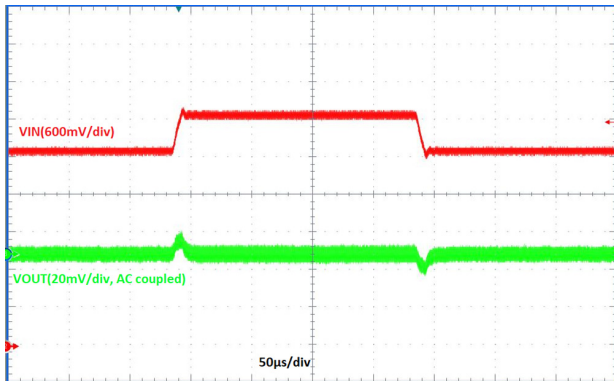

Figure 18. Line Transient,  $V_{IN} = 3.3\text{ V} \leftrightarrow 3.8\text{ V}$ ,  
Slew Rate =  $100\text{ mV}/\mu\text{s}$ ,  $I_{OUT} = 3\text{ A}$

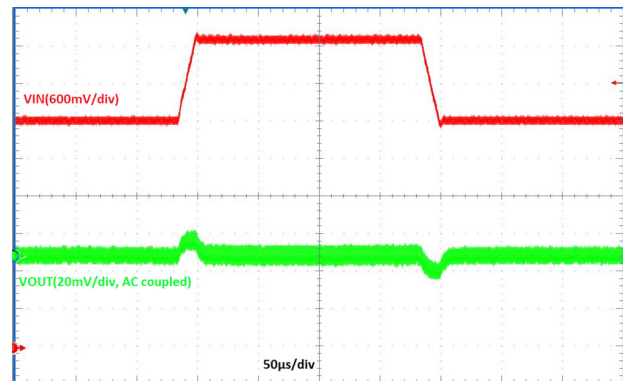

Figure 19. Line Transient,  $V_{IN} = 3.8\text{ V} \leftrightarrow 5\text{ V}$ ,  
Slew Rate =  $100\text{ mV}/\mu\text{s}$ ,  $I_{OUT} = 3\text{ A}$

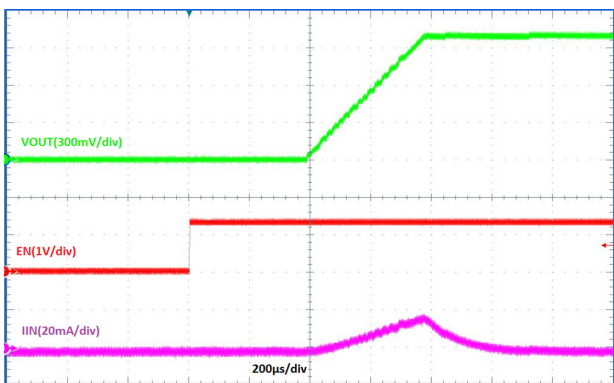

Figure 20. Start-up, No Load

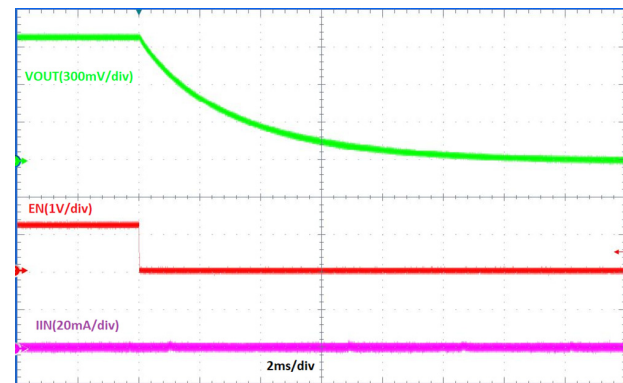

Figure 21. Shut-down, No Load

TYPICAL CHARACTERISTICS (continued)

Unless otherwise specified  $V_{IN} = 3.8\text{ V}$ ,  $V_{OUT} = 1\text{ V}$ ,  $T_A = 25^\circ\text{C}$ , Circuit of Figure 34 and components from [Applications Circuit Components Table](#).

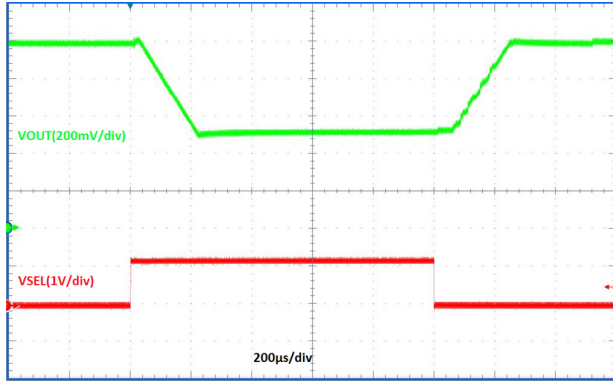

Figure 22. Vsel Toggle,  $V_{OUT} = 1\text{ V}$  to  $0.5\text{ V}$  to  $1\text{ V}$ , No Load, [DVS\_FCCM] = 1

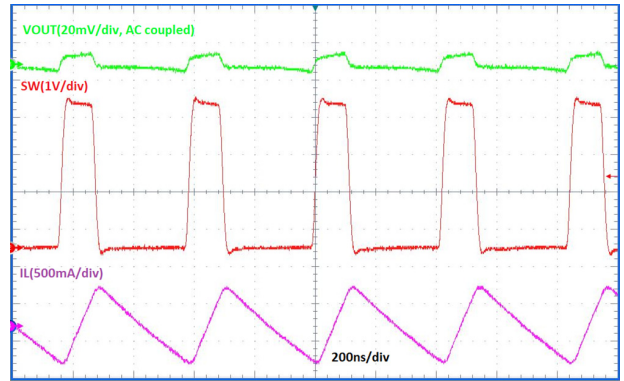

Figure 23. Device Switching (FCCM),  $I_{OUT} = 10\text{ mA}$

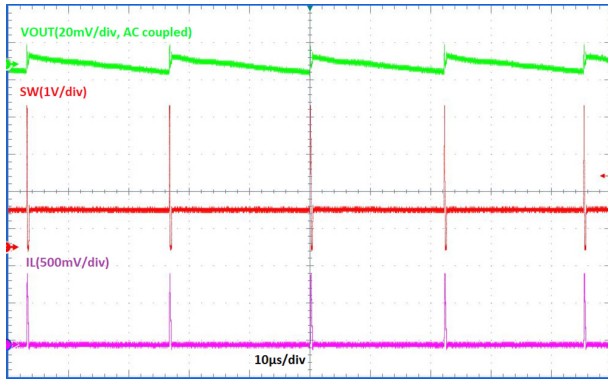

Figure 24. Device Switching (DCM),  $I_{OUT} = 10\text{ mA}$

# FAN53730

## FUNCTIONAL SPECIFICATIONS

### Device Options

#### Options and Features

The FAN53730 has two options:

1. A fully programmable I<sup>2</sup>C version.
2. A logic controlled fixed output voltage version.

The following table lists the differences between the two:

#### FAN53730 FEATURE BREAKDOWN

Feature	Logic Controlled Device	I <sup>2</sup> C Controlled Device
Enable (EN)	Logic Enable Input Only	Logic Enable Input and Enable Bit
Thermal Shutdown	Yes, 150°C	Yes, 150°C
Under Voltage Lockout (UVLO)	Yes	Yes
Power Good Output (PG)	Yes (goes open drain when V <sub>OUT</sub> > 93% of target)	Yes (programmable active high or active low)
Output Pull-Down	Yes, In shutdown (100 Ω)	Yes, In shutdown (100 Ω). Can be disabled via I <sup>2</sup> C
Forced Continuous Conduction (FCCM)	Yes, via FCCM input	Yes, via I <sup>2</sup> C or when VSEL = High and [VSEL_FCCM] = 1
Voltage Select Input (VSEL)	Yes, VSET1 and VSET2 are fixed by device voltage options	Yes, VSET1 and VSET2 targets are programmable
Audio Reduction Mode (ARM)	No (disabled)	Yes, can be enabled via I <sup>2</sup> C
Valley Current Limit	Fixed at 4.6 A (typ)	Programmable to 4.6 A or 2.3 A to accommodate different sized inductors
Dynamic Voltage Scaling	Yes	Yes, 8 programmable slew rates. Can be disabled via I <sup>2</sup> C
Low Power Mode (PFM) During Light Load	Yes	Yes, can be disabled via I <sup>2</sup> C
Output Short Fault	Yes	Yes
Fault Auto-Restart / Shutdown	Auto-Restart	Can be programmed to auto-restart after a fault, or go into shutdown

### Overview

#### Constant On-Time Operation (COT)

The FAN53730 is a constant on-time (COT) synchronous buck which regulates a 0.3 V to 2 V output voltage from a 2.3 V to 5.5 V input voltage. The COT controller operates as follows:

When the output voltage falls out of regulation the input power switch turns on for the fixed on time (t<sub>ON</sub>) and ramps the inductor current. At the end of t<sub>ON</sub> the input switch turns off and the low side synchronous FET turns on and discharges the inductor into the output. If the inductor current reaches 0 before the load pulls the output voltage out of regulation, both the input FET and the synchronous FET will turn off and the device enters an idle state where it will remain until the output falls below the regulation target. Once the output falls below the regulation target the switching action starts again. This results in a variable frequency operation (load dependent) for light currents. At higher load currents (dependent on V<sub>IN</sub>, and V<sub>OUT</sub>) the

inductor current will no longer hit 0 before the output voltage falls out of regulation. This results in an approximate constant switching frequency at heavy loads.

#### On-Time and Maximum Switching Frequency

The Buck switch on-time (t<sub>ON</sub>) varies with V<sub>IN</sub> and V<sub>OUT</sub> in order to approximately target a 2.5 MHz switching frequency at V<sub>IN</sub> = 3.8 V and V<sub>OUT</sub> = 1 V, when the device is operating in continuous conduction mode. Although this switching frequency will have some variation due to delays and non-linearities in the timing circuit, as well as load dependence effects due to resistive drops that make the effective V<sub>IN</sub> lower. Typical CCM frequency variation is shown in the typical operating characteristic graphs.

#### Efficiency

The load dependent switching frequency allows the buck converter to only switch as necessary to keep the load in regulation. This provides for an optimum efficiency response vs load, as the light load switching losses are

minimized. When forced CCM (FCCM) is enabled the light load efficiency will be drastically reduced due to increased switching losses.

**Low Power Mode**

During low output current conditions the idle state can be very long compared to the on and off times. During these conditions (typically for  $I_{OUT} < 2 \text{ mA}$ ), the FAN53730 will enter a low power state where the device is shutdown during the idle period. This results in low quiescent current.

**Enable Input**

The Enable input (EN) is an active high device enable. When EN is driven low the FAN53730 is in a low power shutdown mode. When driven high the device is in the active state and the output is regulating at its target voltage. For the I<sup>2</sup>C controlled device, the EN input must be high and the ENABLE (REG 06h[0]) bit set to 1 to enable the device.

In the shutdown state, the output pull-down (typically 100 Ω) is active and  $V_{OUT}$  will discharge to GND. The I<sup>2</sup>C version has the ability to disable the active pull-down. The EN input is a high impedance input and should not be left floating.

**Soft-Start**

The FAN53730 incorporates a soft-start which ramps the output from 0 to the target voltage during turn-on. This will limit the high input in-rush current during start-up. The soft-start ramp uses the same ramp as the DVS, but soft-start cannot be disabled using the DVS\_EN (Reg 06h [4]) bit. The default start-up ramp time is set to 4 μs per step which results in a soft-start ramp time of typically 400 μs with  $V_{OUT} = 1 \text{ V}$  and no load. This is in addition to approximately 400 μs of initialization time for the bias and reference to wake-up.

Additionally, the device will always start-up in DCM mode until the  $V_{OUT}$  ramp is done, even if the part is set for FCCM.

**Power Good**

**Power Good Output**

Power Good (PG) is an open drain output which is active when  $V_{OUT}$  rises above 93% of the regulation target and when the  $V_{OUT}$  ramp has completed. PG will remain active as long as: the output is enabled,  $V_{OUT}$  is above 93% of the  $V_{OUT}$  target, and no faults are detected (PG is inactive in the FAULT state). The following figure details the operation of PG when set for active high operation.

1. EN goes high and the bias and reference are enabled.
2. After the 400 μs start-up delay,  $V_{OUT}$  begins ramping to the target voltage. During this time PG is low.
3. When the  $V_{OUT}$  ramp stops and  $V_{OUT}$  is higher than 93% of the target, a 128 μs de-glitch timer starts. If  $V_{OUT}$  remains above 93% of the target voltage during the de-glitch timer, PG is pulled high.
4. When a voltage change occurs which forces  $V_{OUT}$  to a higher level, PG goes low.
5. After the  $V_{OUT}$  ramp completes and the 128 μs de-glitch timer expires, PG goes high.
6. When  $V_{OUT}$  is set to a new lower voltage, PG remains high because  $V_{OUT}$  is above 93% of the new target voltage.
7. If  $V_{OUT}$  is forced below 93% of the target voltage for  $t > 128 \mu\text{s}$  (or if any fault occurs PG will pull-low).
8. PG will go high again if the condition which forced  $V_{OUT}$  to drop is removed and  $V_{OUT}$  again rises above 93% of the target output voltage (after 128 μs de-glitch timer expires).
9. When enable is brought low, the PG output will pull low immediately.

During a fault condition, PG will pull low after the fault passes the de-glitch time. This can make PG inactive sooner than the 128 μs de-glitch time (see below).

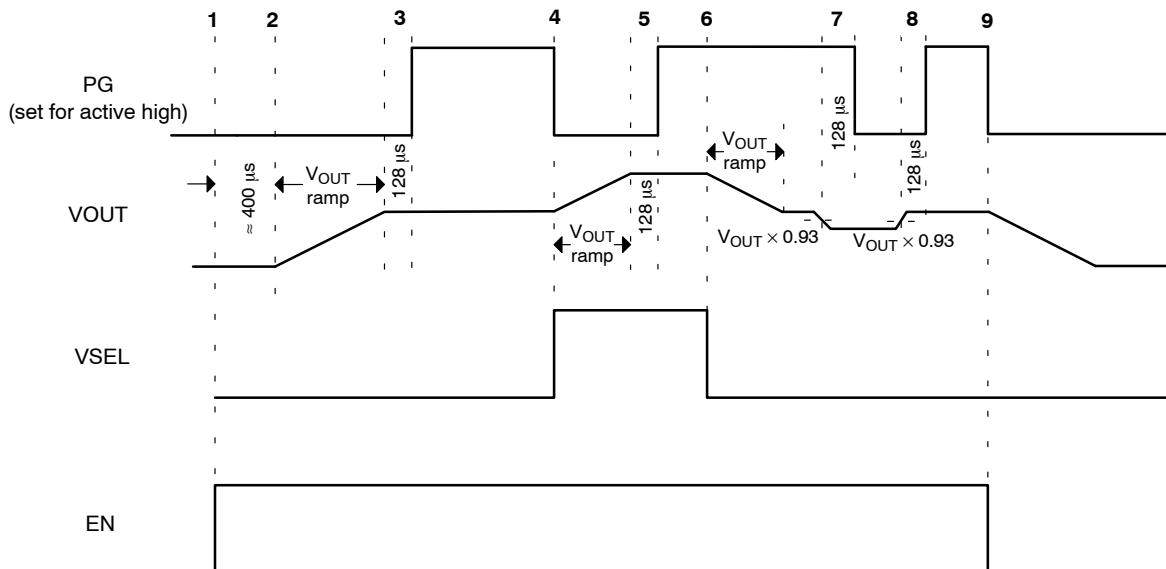

Figure 25. PG Operation

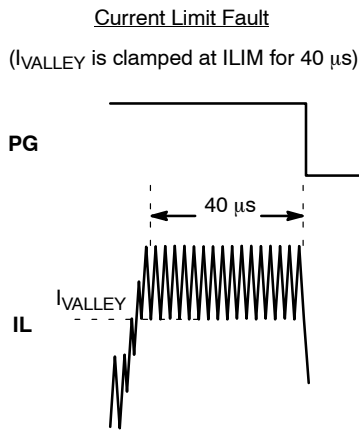

Figure 26. Current Limit Fault

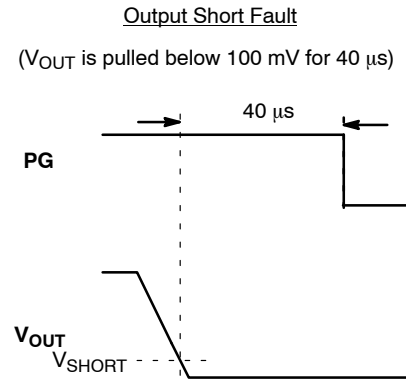

Figure 27. UVLO Fault

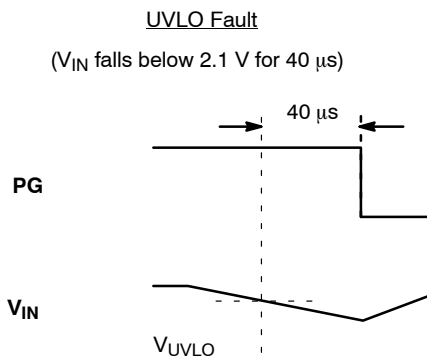

Figure 28. Output Short Fault

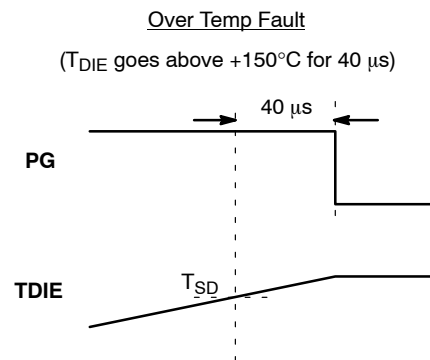

Figure 29. Over Temperature Fault

*Power Good Polarity*

The PG polarity bit, PG\_POL (Reg 03h [0]), sets the active state of the power good output. By default, the PG output will go open drain (externally pulled high) in the active state. When PG\_POL is set to 0, the PG output will pull low in the active state.

*Power Good Bit*

The POWER\_GOOD (Reg 01h [5]) bit sets to 1 when the PG output is in its active state.

**Output Pull-Down**

*Output Pull-Down*

During shutdown and fault timeout, the output has a 100  $\Omega$  pull-down. The pull-down resistor can be disabled via OUT\_DISCHARGE (Reg06h[3]).

**UVLO**

*UVLO Rising*

The Under Voltage Lockout (UVLO) holds the device in shutdown until  $V_{IN}$  rises above the UVLO rising threshold.

*UVLO Falling*

If  $V_{IN}$  falls below the UVLO falling threshold, the FAN53730 will trigger a UVLO event and shutdown.

**Valley Current Limit**

*Valley Current Limit*

In CCM operation the FAN53730 will regulate the valley of the inductor current in order to keep  $V_{OUT}$  at its target voltage. However, there is a maximum valley inductor current capability ( $I_{VALLEY}$ ) allowed in the FAN53730's power path. When  $I_{OUT}$  increases to the point where the inductor valley current reaches  $I_{VALLEY}$ , the FAN53730's control loop will be clamped at this valley current limit threshold and will no longer be able to regulate  $V_{OUT}$  at the target voltage. When this happens  $V_{OUT}$  will tend to drop out. The maximum output current from the FAN53730 is approximately:

$$I_{OUT\_MAX} = I_{VALLEY} + (V_{IN} - V_{OUT}) / (2L) \times t_{ON} \quad (\text{eq. 1})$$

where  $I_{VALLEY}$  is the valley current limit threshold. For the logic controlled device  $I_{VALLEY}$  is fixed at VAL\_ILIM (Reg 03h [0]) = 1. For the I<sup>2</sup>C controlled device VAL\_ILIM is programmable.

For inductor selection, typically the peak inductor current is required. Keep in mind that the peak inductor current will typically be 20% to 30% higher than the valley current.

## FAN53730

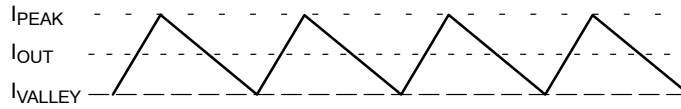

$$I_{OUT\_MAX} = I_{VALLEY} + (V_{IN} - V_{OUT}) \times t_{ON} / (2 \times L)$$

$$I_{PEAK} = I_{OUT} + (V_{IN} - V_{OUT}) \times t_{ON} / (2 \times L)$$

For example:

$$V_{OUT} = 1 \text{ V}, V_{IN} = 3.8 \text{ V}, I_{VALLEY} = 4.6 \text{ A}$$

$$I_{PEAK} = 4.6 \text{ A} + (3.8 \text{ V} - 1 \text{ V}) \times 79 \text{ ns} / 0.24 \mu\text{H} = 4.6 \text{ A} + 0.922 \text{ A} = 5.52 \text{ A}$$

**Figure 30. Current Limit Description**

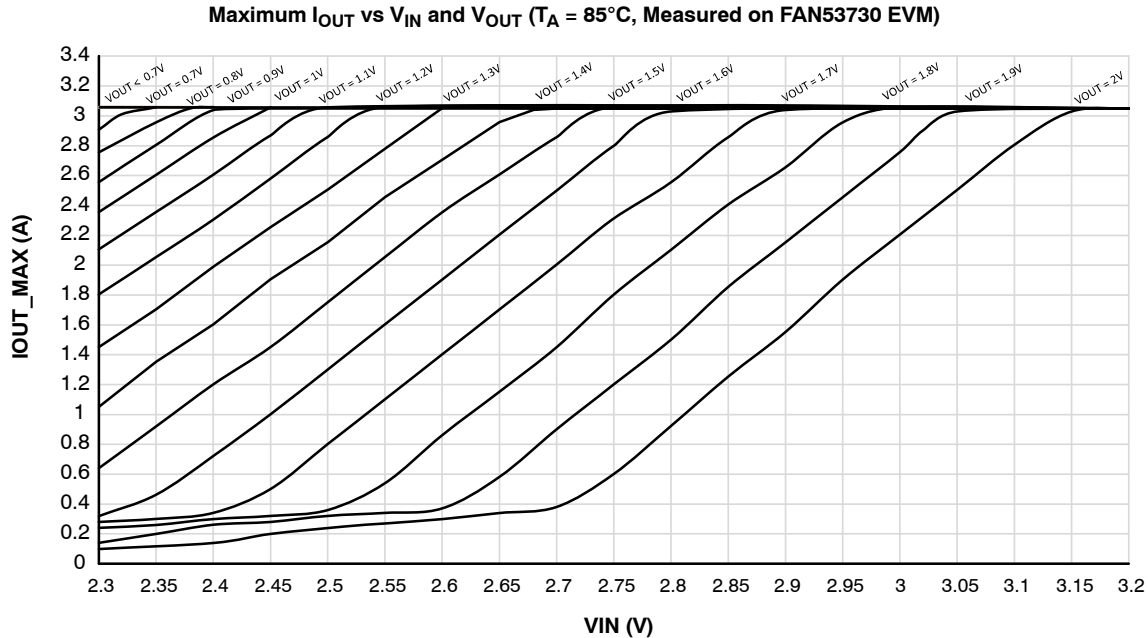

**Figure 31. Typical Derating Curve vs.  $V_{IN}$ ,  $V_{OUT}$ ,  $I_{LOAD}$**

### Maximum Duty Cycle

For some  $V_{IN}$  to  $V_{OUT}$  conditions, the maximum output current can be limited by the device minimum off time ( $t_{OFF\_MIN}$ ), which can be up to 100 ns. This places a limitation on the maximum duty cycle the device can attain in CCM. Parameters which effect the required duty cycle are  $V_{IN}$ ,  $V_{OUT}$ , and  $I_{LOAD}$ . Typically the FAN53730 can reach a duty cycle of  $t_{ON} / (t_{ON} + t_{OFF\_MIN})$  at no load. However, as load increases, the effective voltage across the inductor is less, and the required duty cycle increases. This will limit the maximum current below 3 A for some  $V_{IN}/V_{OUT}$  configurations. Figure 16 shows a typical derating curve for  $V_{IN}$ ,  $V_{OUT}$ , and Load for  $T_A = 85^\circ\text{C}$ . This can be used for targeting the maximum load for different  $V_{IN}/V_{OUT}$  configurations.

### $V_{OUT} < 0.8 \text{ V}$ Operation

If  $V_{OUT} < 0.8 \text{ V}$  ( $VSET1$  or  $VSET2 \leq \text{code } 0x4F$ ), set  $HIGH\_BANDWIDTH$  (Reg 02h [1]) = 0 to avoid low phase margin conditions and possible output voltage oscillations.

### Audio Reduction Mode

#### Audio Reduction Mode

The I<sup>2</sup>C controlled device features an Audio Reduction Mode (ARM). In this mode the switching frequency is kept above a programmed target frequency to eliminate audible noise typically generated in ceramic capacitors with changing electric fields. The ARM is enabled by setting  $ARM\_EN$  (Reg 06h [5]) = 1. When enabled, the Buck's DCM idle time (dead time between switching events) is monitored. If  $t_{IDLE}$  reaches the programmed maximum period before the start of a new  $t_{ON}$ , then the synchronous MOSFET will be forced on long enough to pull  $V_{OUT}$  out of regulation and force a new switching cycle. This forced switching period is approximately equal to the ARM time-out period. Programmable timeout periods are 25  $\mu\text{s}$  and 40  $\mu\text{s}$  (see  $ARM\_TO$  (Reg 02h [6])) which result in minimum allowed frequency targets of  $1/40 \mu\text{s} = 25 \text{ kHz}$  and  $1/25 \mu\text{s} = 40 \text{ kHz}$ .

**Dynamic Voltage Scaling**

*Dynamic Voltage Scaling (DVS)*

The I<sup>2</sup>C controlled device features a Dynamic Voltage Scaling mode (DVS), which is the controlled slewing of the output voltage (up or down) depending on the direction of the new target output voltage. The slewing of V<sub>OUT</sub> (or ramp

rate) is done by incrementing through each voltage set-point (10 mV/step) between the current target and the new target, until the new target voltage is reached. The time per step is programmable using RR\_DVS (Reg 02h [4:2]). Programmable times per step are shown below:

**DVS PROGRAMMABLE TIME PER STEP**

DVS_EN	RR_DVS	Time per Step
0	XXX	Immediate
1	000	2 μs/step
1	001	4 μs/step
1	010	6 μs/step
1	011	8 μs/step
1	100	10 μs/step
1	101	12 μs/step
1	110	14 μs/step
1	111	16 μs/step

*For example:* DVS is enabled with RR\_DVS set to 10 μs/step. V<sub>OUT</sub> is initially set to 0.5 V and has reached steady state. V<sub>OUT</sub> is then programmed to 1 V. The output will increment from 0.5 V to 1 V through each voltage set-point (10 mV/step) with a pause at each step of 10 μs. The total ramp time is given as:

$$[(1000 \text{ mV} - 500 \text{ mV}) / (10 \text{ mV/step}) - 1] \times 10 \text{ μs/step} = 490 \text{ μs}$$

During negative transitions (high voltage to lower voltage), if there is a no load condition the output can take a long time to decay to its new target. There is an option to have FCCM turn on during high to low voltage transitions in order to rapidly bring V<sub>OUT</sub> down to its new target (see DVS\_FCCM (Reg 02h [5])).

DVS control also applies when the output voltage transitions between VSET1 and VSET2 settings following a VSEL change.

The DVS control can be disabled with the DVS\_EN (Reg 06h [4] bit, in which case any V<sub>OUT</sub> transition will immediately change to the new value without a ramp. However, disabling the DVS ramp will not effect the ramp during soft-start. Soft-start will continue to use the programmed DVS setting regardless of the setting of DVS\_EN. Additionally, disabling the DVS ramp with FORCE\_FCCM = 1 will still utilize slew rate control during high to low voltage transitions.

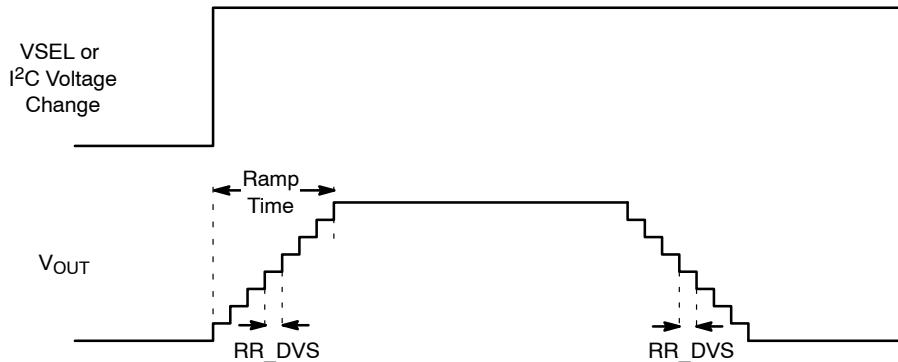

**Figure 32. DVS Voltage Ramp**



**Forced Continuous Conduction Mode**

*Forced Continuous Conduction Mode (FCCM)*

Forced continuous conduction mode will disable the zero cross detection and allow the inductor current to conduct negative during light load conditions. This allows the FAN53730 to switch continuously at all loads. FCCM is beneficial when the DCM switching frequency would cause unwanted noise and interference. During constant frequency operation, the light load efficiency will be much lower compared to variable frequency operation due to higher switching losses in the converter.

The I<sup>2</sup>C controlled device has a dedicated bit for FCCM, FORCE\_CCM (Reg 06h [1]). The logic controlled device has a dedicated pin, called FCCM, for this feature.

The figure below shows the basic differences between DCM and CCM operation. DCM operation occurs for light

load conditions while CCM operation occurs at heavy load or if the FCCM control is set. In DCM, the device will switch once and then enter the idle state. During the idle state, I<sub>OUT</sub> will continue to discharge the output capacitor. When V<sub>OUT</sub> falls below the regulation target, a new switching cycle is initiated. This causes V<sub>OUT</sub> to regulate to the bottom of the output voltage ripple, and the average value to be slightly higher than V<sub>OUT</sub> + ΔV<sub>OUT\_DCM</sub>/2. In CCM operation (either with FCCM high or at heavy loads when V<sub>OUT</sub> falls out of regulation before I<sub>L</sub> reaches zero), the output voltage is regulated via a high gain feedback loop. This causes the average value of V<sub>OUT</sub> to become the regulation target. The parameters listed in the following figure are approximations because they ignore circuit losses and circuit delays, but can give a good idea of the various buck converter operating conditions.

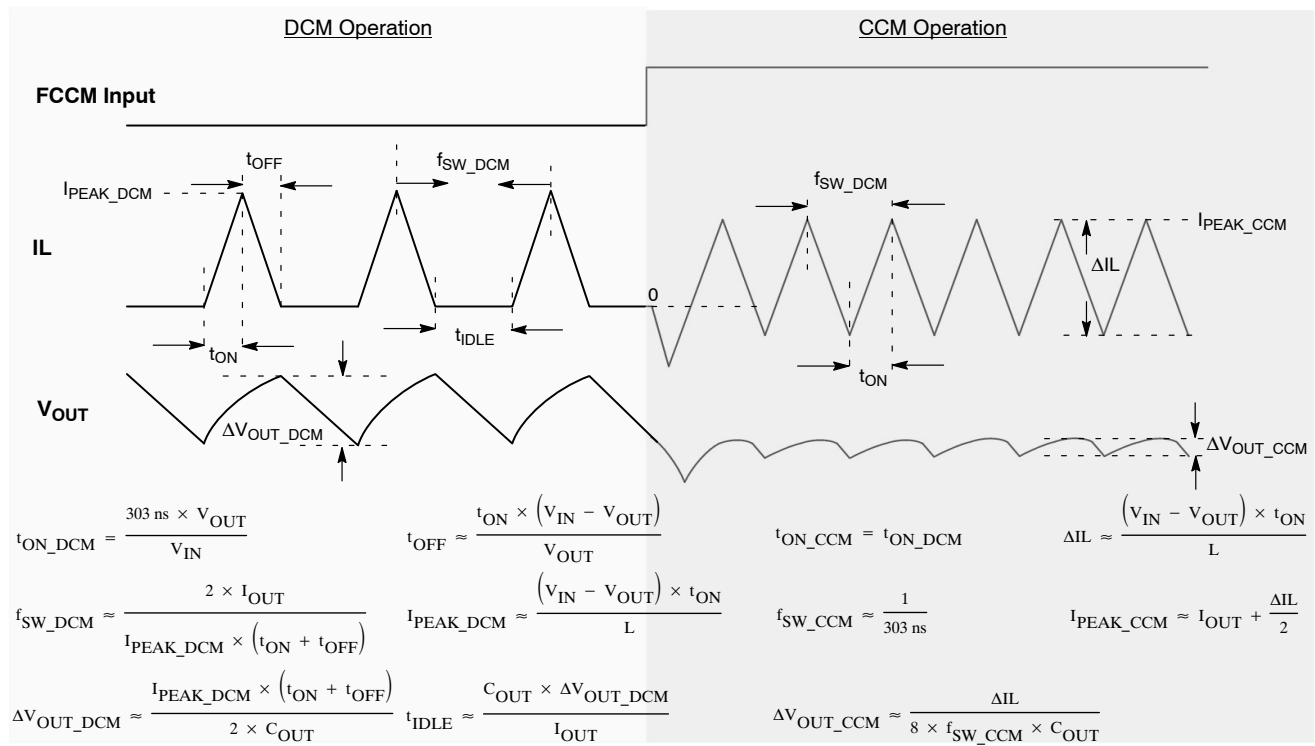

**Figure 33. DCM vs. CCM Operation**

**Voltage Select Input**

*Voltage Select (VSEL Input)*

VSEL is a logic input which shifts V<sub>OUT</sub> between two target voltages. In the logic controlled device, VSEL will shift the target output voltage to the fixed VSET2 level when driven to a logic high. When VSEL is driven to a logic low, the output voltage will shift to the fixed VSET1 target.

In the I<sup>2</sup>C controlled device the VSEL input operates the same except the VSET1 and VSET2 targets are programmable.

*FCCM Tied to VSEL*

Forced continuous conduction mode (FCCM) can be made to follow the VSEL input by enabling the VSEL\_FCCM (Reg 06h [2]) bit. When this bit is set, a logic high at VSEL will change the V<sub>OUT</sub> target and will place the buck in FCCM. If this bit is not set, the device remains in auto mode when VSEL is high or low. The FORCE\_CCM bit will always override the VSEL\_FCCM setting. See following table.

**VSEL AND FCCM**

FORCE_CCM bit	VSEL_FCCM bit	VSEL Input	Result
0	X	0	VOUT = VSET1 target and buck is in Auto DCM/CCM
0	0	1	VOUT = VSET2 target and buck is in Auto DCM/CCM
0	1	1	VOUT = VSET2 target and buck is in FCCM
1	X	0	VOUT = VSET1 target and buck is in FCCM
1	X	1	VOUT = VSET2 target and buck is in FCCM

**Bias Modes**

The I<sup>2</sup>C controlled device has three programmable bias mode options for reducing the device’s quiescent current. These BIAS\_MODE (Reg 03h [2:1]) bits disable infrequently used internal logic blocks during long SW idle periods, as described below:

*High Bias Mode*

All circuitry active when the part is enabled. Under certain conditions this mode can provide for a faster response to transient disturbances, but at the expense of higher quiescent current.

*Low Bias Mode*

Forces some of the FAN53730’s circuitry into shutdown during the DCM idle state. This will greatly reduce no load quiescent current, but under certain conditions can lead to a slower response to a transient event.

*Ultra Low Bias Mode*

This mode is the default selection and will provide the lowest no load quiescent current. The logic version of the device also has the Low Bias Mode option enabled.

**Protection Features**

*Fault Protection*

The FAN53730 contains 4 fault modes consisting of:

- V<sub>IN</sub> UVLO Fault
- Current Limit Fault
- Output Short Fault
- Thermal Fault

When any of these faults occur, the FAN53730 is placed in the fault state and is shutdown. By default, the OUT\_DISCHARGE (Reg 06h [3]) bit enables the output discharge resistor during shutdown.

During Current Limit and Output Short faults the converter will auto–restart every 20 ms. This feature can be

disabled by setting FAULT\_SHDN (Reg 03h [3]) = 1, and instead the ENABLE bit will be reset to 0 (device remains in shutdown).

*Under Voltage Fault*

A V<sub>IN</sub> UVLO is detected if V<sub>IN</sub> falls below the UVLO\_F threshold for 40 μs. Once this happens, the device stops switching and is placed in the Fault State. In the I<sup>2</sup>C version the UVLO\_FAULT Flag is set. If V<sub>IN</sub> continues to fall past the UVLO threshold and crosses the power on reset threshold, the FAN53730 will immediately shutdown.

*Current Limit Timeout*

During valley current limit events, when I<sub>L</sub> is clamped at I<sub>VALLEY</sub>, the fault clock begins counting. If the fault clock reaches 40 μs of a continuous valley current limit condition, the device is placed into the fault state. During the fault count, if a period occurs without a valley current limit clamp event then the count is reset to 0.

In the I<sup>2</sup>C version, when the part is placed into the fault state, the ILIM\_FAULT flag is set.

*Output Short Fault*

If the output voltage falls below 100 mV for 40 μs, after the device has reached the active state (power good), the device will detect an output short fault and be forced into the fault state.

In the I<sup>2</sup>C version, when the part is placed into the fault state, the SHORT\_FAULT flag is set.

*Thermal Shutdown*

When the die temperature increases due to a high load condition and/or a high ambient temperature, the FAN53730 can reach a thermal fault condition and be placed in the Fault State. In the I<sup>2</sup>C version the OVER\_TEMP\_FAULT flag is set. The device will restart after it cools below the hysteresis level.

# FAN53730

## Operation

### I<sup>2</sup>C Interface

The I<sup>2</sup>C interface is compatible with Standard, Fast, and Fast Plus I<sup>2</sup>C bus specifications. The SCL line is an input and the SDA line is a bi-directional open-drain output; it can only pull down the bus when active. The SDA line only pulls LOW during data reads and when signaling ACK. All data is shifted in MSB (bit 7) first.

### I<sup>2</sup>C Slave Address

The equivalent 7 bit slave identification for the FAN53730UCX device version is 7h'20. This is followed by the read/write bit (0 = Write) and (1 = Read).

7-Bit	Binary	Hex
7h'20	0100000	8h'40

## REGISTER MAP

REGISTER MAPPING TABLE

Address	Name				Read Only	Write Only	Read / Write	Read / Clear	Write/Clear
		Bit[7]	Bit[6]	Bit[5]	Bit[4]	Bit[3]	Bit[2]	Bit[1]	Bit[0]
0x01	FAULT FLAGS	0		POWER_GOOD	0	UVLO_FAULT	OVER_TEMP_FAULT	SHORT_FAULT	ILIM_FAULT
0x02	CONFIG1	0	ARM_TO	DVS_FCCM	RR_DVS			HIGH_BANDWIDTH	VAL_ILIM
0x03	CONFIG2	0			Transient_Enhancement	FAULT_SHDN	BIAS_MODE		PG_POL
0x04	VOUT_SET_1	VSET1							
0x05	VOUT_SET_2	VSET2							
0x06	ENABLE	0	ARM_EN	DVS_EN	OUT_DISCHARGE	VSEL_FCCM	FORCE_CCM	ENABLE	
0x09	RESET	SOFT_RESET							

# FAN53730

## REGISTER DETAILS

**Table 1. REGISTER DETAILS – 0 × 01 FAULT FLAGS**

<b>0 × 01 FAULT FLAGS</b>				<b>Default = 00000000</b>
<b>Bit</b>	<b>Name</b>	<b>Default</b>	<b>Type</b>	<b>Description</b>
7:6	UNUSED			
5	POWER_GOOD	0	Read	Reset condition: 0 PG Bit (Tracks the state of PG Output Active state)  <i>Code</i> <i>Power Good Status</i> 0                Power good output is not active 1                Power good output is active
4	UNUSED			
3	UVLO_FAULT	0	R/CLR	Reset condition: 0 Displays UVLO fault status. This flag is set when a UVLO fault occurs. The flag is cleared upon read.  <i>Code</i> <i>Input Under Voltage Fault Occurrence</i> 0                No UVLO fault occurred 1                A UVLO fault occurred
2	OVER_TEMP_FAULT	0	R/CLR	Reset condition: 0 Displays over temp fault status. This flag is set when a die over temp fault occurs. The flag is cleared upon read.  <i>Code</i> <i>Die Over Temperature Fault</i> 0                No over temp fault 1                An over temp fault occurred
1	SHORT_FAULT	0	R/CLR	Reset condition: 0 Displays V <sub>OUT</sub> short fault status. This flag is latched when a V <sub>OUT</sub> short fault occurs. The flag is cleared upon read.  <i>Code</i> <i>Vout Short Fault</i> 0                The output has not shorted 1                V <sub>OUT</sub> has dropped below 100 mV for > 40 μs
0	ILIM_FAULT	0	R/CLR	Reset condition: 0 The ILIM flag is set if the valley current limit is triggered continuously for 40 μs. The flag is cleared upon read.  <i>Code</i> <i>VALLEY Current Limit Fault</i> 0                No ILIM fault 1                ILIM triggered event for 40 μs

# FAN53730

**Table 2. REGISTER DETAILS – 0 × 02 CONFIG1**

<b>0 × 02 CONFIG1</b>				<b>Default = 00000111</b>
Bit	Name	Default	Type	Description
7	UNUSED			
6	ARM_TO	0	R/W	Reset condition: 0 Sets the timeout period for Audio Reduction Mode forced switching event  <i>Code            Audio Reduction Mode Timeout</i> 0                25 μs 1                40 μs
5	DVS_FCCM	0	R/W	Reset condition: 0 Controls whether the Force CCM functionality is active when DVS is enabled and the voltage is programmed from high to low.  <i>Code            CCM During high to low DVS Transition</i> 0                Force CCM is not active during negative V <sub>OUT</sub> transitions 1                Force CCM is active during negative V <sub>OUT</sub> transitions
4:2	RR_DVS	001	R/W	Reset condition: 001 DVS (and also Soft-Start) ramp rate  <i>Code            DVS Time per step</i> 000             2 μs/step 001             4 μs/step 010             6 μs/step 011             8 μs/step 100             10 μs/step 101             12 μs/step 110             14 μs/step 111             16 μs/step
1	HIGH_BANDWIDTH	1	R/W	Reset condition: 1 Control loop high bandwidth adjust. Set to "0" when V <sub>OUT</sub> < 0.8 V.  <i>Code            Bandwidth Adjust</i> 0                Low Bandwidth setting 1                High Bandwidth setting
0	VAL_ILIM	1	R/W	Reset condition: 1 Valley Current Limit threshold. The FAN53730 will limit the valley of the inductor current to the I <sub>VALLEY</sub> target.  <i>Code            I<sub>VALLEY</sub> (Typ)</i> 0                2.3 A 1                4.2 A

# FAN53730

**Table 3. REGISTER DETAILS – 0 × 03 CONFIG2**

<b>0 × 03 CONFIG2</b>				<b>Default = 00010001</b>
<b>Bit</b>	<b>Name</b>	<b>Default</b>	<b>Type</b>	<b>Description</b>
7:5	UNUSED			
4	TRANSIENT_ENHANCEMENT	1	R/W	Reset condition: 1 Transient Enhancement Mode  <i>Code</i> <i>Transient Enhancement Mode</i> 0                    Transient Enhancement Disabled 1                    Transient Enhancement Enabled
3	FAULT_SHDN	0	R/W	Reset condition: 0  This register enables/disables the shutdown option for faults. <u>Note:</u> For proper operation, this bit should only be written to when the device is in the shutdown state.  <i>Code</i> <i>Fault Shutdown Control</i> 0                    The converter will auto-restart after 20 ms if a fault occurs 1                    The converter will be placed into shutdown if a fault occurs
2:1	BIAS_MODE	00	R/W	Reset condition: 1X  Sets the converters ability to shutdown various blocks to achieve low quiescent current vs. output accuracy and response time.  <i>Code</i> <i>Low Bias Mode Control</i> 00                  Ultra Low Bias Mode 01                  Low Bias Mode 1X                  High Bias Mode
0	PG_POL	1	R/W	Reset condition: 1  Changes the polarity of the Power-Good Output  <i>Code</i> <i>Power-Good Polarity</i> 0                    PG output is active low 1                    PG output is active high

# FAN53730

Table 4. REGISTER DETAILS – 0 × 04 VOUT\_SET\_1

0 × 04 VOUT_SET_1				Default = 01100011 (1.00 V)							
Bit	Name	Default	Type	Description							
7:0	VSET1	01100011	R/W	Reset conditions: 0 × 63							
				Sets the buck regulation target voltage when VSEL = low.							
				<i>Hex</i>	<i>VOUT(V)</i>	<i>Hex</i>	<i>VOUT(V)</i>	<i>Hex</i>	<i>VOUT(V)</i>	<i>Hex</i>	<i>VOUT(V)</i>
				0 × 00	0.0100	0 × 40	0.6500	0 × 80	1.2900	0 × C0	1.9300
				0 × 01	0.0200	0 × 41	0.6600	0 × 81	1.3000	0 × C1	1.9400
				0 × 02	0.0300	0 × 42	0.6700	0 × 82	1.3100	0 × C2	1.9500
				0 × 03	0.0400	0 × 43	0.6800	0 × 83	1.3200	0 × C3	1.9600
				0 × 04	0.0500	0 × 44	0.6900	0 × 84	1.3300	0 × C4	1.9700
				0 × 05	0.0600	0 × 45	0.7000	0 × 85	1.3400	0 × C5	1.9800
				0 × 06	0.0700	0 × 46	0.7100	0 × 86	1.3500	0 × C6	1.9900
				0 × 07	0.0800	0 × 47	0.7200	0 × 87	1.3600	0 × C7	2.0000
				0 × 08	0.0900	0 × 48	0.7300	0 × 88	1.3700	0 × C8	2.0100
				0 × 09	0.1000	0 × 49	0.7400	0 × 89	1.3800	0 × C9	2.0200
				0 × 0A	0.1100	0 × 4A	0.7500	0 × 8A	1.3900	0 × CA	2.0300
				0 × 0B	0.1200	0 × 4B	0.7600	0 × 8B	1.4000	0 × CB	2.0400
				0 × 0C	0.1300	0 × 4C	0.7700	0 × 8C	1.4100	0 × CC	2.0500
				0 × 0D	0.1400	0 × 4D	0.7800	0 × 8D	1.4200	0 × CD	2.0600
				0 × 0E	0.1500	0 × 4E	0.7900	0 × 8E	1.4300	0 × CE	2.0700
				0 × 0F	0.1600	0 × 4F	0.8000	0 × 8F	1.4400	0 × CF	2.0800
				0 × 10	0.1700	0 × 50	0.8100	0 × 90	1.4500	0 × D0	2.0900
				0 × 11	0.1800	0 × 51	0.8200	0 × 91	1.4600	0 × D1	2.1000
				0 × 12	0.1900	0 × 52	0.8300	0 × 92	1.4700	0 × D2	2.1100
				0 × 13	0.2000	0 × 53	0.8400	0 × 93	1.4800	0 × D3	2.1200
				0 × 14	0.2100	0 × 54	0.8500	0 × 94	1.4900	0 × D4	2.1300
				0 × 15	0.2200	0 × 55	0.8600	0 × 95	1.5000	0 × D5	2.1400
				0 × 16	0.2300	0 × 56	0.8700	0 × 96	1.5100	0 × D6	2.1500
				0 × 17	0.2400	0 × 57	0.8800	0 × 97	1.5200	0 × D7	2.1600
0 × 18	0.2500	0 × 58	0.8900	0 × 98	1.5300	0 × D8	2.1700				
0 × 19	0.2600	0 × 59	0.9000	0 × 99	1.5400	0 × D9	2.1800				
0 × 1A	0.2700	0 × 5A	0.9100	0 × 9A	1.5500	0 × DA	2.1900				
0 × 1B	0.2800	0 × 5B	0.9200	0 × 9B	1.5600	0 × DB	2.2000				
0 × 1C	0.2900	0 × 5C	0.9300	0 × 9C	1.5700	0 × DC	2.2100				
0 × 1D	0.3000	0 × 5D	0.9400	0 × 9D	1.5800	0 × DD	2.2200				
0 × 1E	0.3100	0 × 5E	0.9500	0 × 9E	1.5900	0 × DE	2.2300				
0 × 1F	0.3200	0 × 5F	0.9600	0 × 9F	1.6000	0 × DF	2.2400				
0 × 20	0.3300	0 × 60	0.9700	0 × A0	1.6100	0 × E0	2.2500				
0 × 21	0.3400	0 × 61	0.9800	0 × A1	1.6200	0 × E1	2.2600				
0 × 22	0.3500	0 × 62	0.9900	0 × A2	1.6300	0 × E2	2.2700				
0 × 23	0.3600	0 × 63	1.0000	0 × A3	1.6400	0 × E3	2.2800				
0 × 24	0.3700	0 × 64	1.0100	0 × A4	1.6500	0 × E4	2.2900				
0 × 25	0.3800	0 × 65	1.0200	0 × A5	1.6600	0 × E5	2.3000				

# FAN53730

**Table 4. REGISTER DETAILS – 0 × 04 VOUT\_SET\_1 (continued)**

<b>0 × 04 VOUT SET1</b>				<b>Default = 01100011 (1.00 V)</b>							
<b>Bit</b>	<b>Name</b>	<b>Default</b>	<b>Type</b>	<b>Description</b>							
7:0	VSET1	01100011	R/W	Reset conditions: 0 × 63							
				Sets the buck regulation target voltage when VSEL = low.							
				<i>Hex</i>	<i>VOUT(V)</i>	<i>Hex</i>	<i>VOUT(V)</i>	<i>Hex</i>	<i>VOUT(V)</i>	<i>Hex</i>	<i>VOUT(V)</i>
				0 × 26	0.3900	0 × 66	1.0300	0 × A6	1.6700	0 × E6	2.3100
				0 × 27	0.4000	0 × 67	1.0400	0 × A7	1.6800	0 × E7	2.3200
				0 × 28	0.4100	0 × 68	1.0500	0 × A8	1.6900	0 × E8	2.3300
				0 × 29	0.4200	0 × 69	1.0600	0 × A9	1.7000	0 × E9	2.3400
				0 × 2A	0.4300	0 × 6A	1.0700	0 × AA	1.7100	0 × EA	2.3500
				0 × 2B	0.4400	0 × 6B	1.0800	0 × AB	1.7200	0 × EB	2.3600
				0 × 2C	0.4500	0 × 6C	1.0900	0 × AC	1.7300	0 × EC	2.3600
				0 × 2D	0.4600	0 × 6D	1.1000	0 × AD	1.7400	0 × ED	2.3600
				0 × 2E	0.4700	0 × 6E	1.1100	0 × AE	1.7500	0 × EE	2.3600
				0 × 2F	0.4800	0 × 6F	1.1200	0 × AF	1.7600	0 × EF	2.3600
				0 × 30	0.4900	0 × 70	1.1300	0 × B0	1.7700	0 × F0	2.3600
				0 × 31	0.5000	0 × 71	1.1400	0 × B1	1.7800	0 × F1	2.3600
				0 × 32	0.5100	0 × 72	1.1500	0 × B2	1.7900	0 × F2	2.3600
				0 × 33	0.5200	0 × 73	1.1600	0 × B3	1.8000	0 × F3	2.3600
				0 × 34	0.5300	0 × 74	1.1700	0 × B4	1.8100	0 × F4	2.3600
				0 × 35	0.5400	0 × 75	1.1800	0 × B5	1.8200	0 × F5	2.3600
				0 × 36	0.5500	0 × 76	1.1900	0 × B6	1.8300	0 × F6	2.3600
				0 × 37	0.5600	0 × 77	1.2000	0 × B7	1.8400	0 × F7	2.3600
				0 × 38	0.5700	0 × 78	1.2100	0 × B8	1.8500	0 × F8	2.3600
				0 × 39	0.5800	0 × 79	1.2200	0 × B9	1.8600	0 × F9	2.3600
				0 × 3A	0.5900	0 × 7A	1.2300	0 × BA	1.8700	0 × FA	2.3600
				0 × 3B	0.6000	0 × 7B	1.2400	0 × BB	1.8800	0 × FB	2.3600
				0 × 3C	0.6100	0 × 7C	1.2500	0 × BC	1.8900	0 × FC	2.3600
				0 × 3D	0.6200	0 × 7D	1.2600	0 × BD	1.9000	0 × FD	2.3600
0 × 3E	0.6300	0 × 7E	1.2700	0 × BE	1.9100	0 × FE	2.3600				
0 × 3F	0.6400	0 × 7F	1.2800	0 × BF	1.9200	0 × FF	2.3600				



# FAN53730

**Table 5. REGISTER DETAILS – 0 × 05 VOUT\_SET\_2**

0 × 05 VOUT SET2				Default = 01101000 (1.05 V)							
Bit	Name	Default	Type	Description							
7:0	VSET2	01101000	R/W	Reset conditions: 0 × 68							
				Sets the buck regulation target voltage when VSEL = high.							
				<i>Hex</i>	<i>VOUT(V)</i>	<i>Hex</i>	<i>VOUT(V)</i>	<i>Hex</i>	<i>VOUT(V)</i>	<i>Hex</i>	<i>VOUT(V)</i>
				0 × 00	0.0100	0 × 40	0.6500	0 × 80	1.2900	0 × C0	1.9300
				0 × 01	0.0200	0 × 41	0.6600	0 × 81	1.3000	0 × C1	1.9400
				0 × 02	0.0300	0 × 42	0.6700	0 × 82	1.3100	0 × C2	1.9500
				0 × 03	0.0400	0 × 43	0.6800	0 × 83	1.3200	0 × C3	1.9600
				0 × 04	0.0500	0 × 44	0.6900	0 × 84	1.3300	0 × C4	1.9700
				0 × 05	0.0600	0 × 45	0.7000	0 × 85	1.3400	0 × C5	1.9800
				0 × 06	0.0700	0 × 46	0.7100	0 × 86	1.3500	0 × C6	1.9900
				0 × 07	0.0800	0 × 47	0.7200	0 × 87	1.3600	0 × C7	2.0000
				0 × 08	0.0900	0 × 48	0.7300	0 × 88	1.3700	0 × C8	2.0100
				0 × 09	0.1000	0 × 49	0.7400	0 × 89	1.3800	0 × C9	2.0200
				0 × 0A	0.1100	0 × 4A	0.7500	0 × 8A	1.3900	0 × CA	2.0300
				0 × 0B	0.1200	0 × 4B	0.7600	0 × 8B	1.4000	0 × CB	2.0400
				0 × 0C	0.1300	0 × 4C	0.7700	0 × 8C	1.4100	0 × CC	2.0500
				0 × 0D	0.1400	0 × 4D	0.7800	0 × 8D	1.4200	0 × CD	2.0600
				0 × 0E	0.1500	0 × 4E	0.7900	0 × 8E	1.4300	0 × CE	2.0700
				0 × 0F	0.1600	0 × 4F	0.8000	0 × 8F	1.4400	0 × CF	2.0800
				0 × 10	0.1700	0 × 50	0.8100	0 × 90	1.4500	0 × D0	2.0900
				0 × 11	0.1800	0 × 51	0.8200	0 × 91	1.4600	0 × D1	2.1000
				0 × 12	0.1900	0 × 52	0.8300	0 × 92	1.4700	0 × D2	2.1100
				0 × 13	0.2000	0 × 53	0.8400	0 × 93	1.4800	0 × D3	2.1200
				0 × 14	0.2100	0 × 54	0.8500	0 × 94	1.4900	0 × D4	2.1300
				0 × 15	0.2200	0 × 55	0.8600	0 × 95	1.5000	0 × D5	2.1400
				0 × 16	0.2300	0 × 56	0.8700	0 × 96	1.5100	0 × D6	2.1500
				0 × 17	0.2400	0 × 57	0.8800	0 × 97	1.5200	0 × D7	2.1600
0 × 18	0.2500	0 × 58	0.8900	0 × 98	1.5300	0 × D8	2.1700				
0 × 19	0.2600	0 × 59	0.9000	0 × 99	1.5400	0 × D9	2.1800				
0 × 1A	0.2700	0 × 5A	0.9100	0 × 9A	1.5500	0 × DA	2.1900				
0 × 1B	0.2800	0 × 5B	0.9200	0 × 9B	1.5600	0 × DB	2.2000				
0 × 1C	0.2900	0 × 5C	0.9300	0 × 9C	1.5700	0 × DC	2.2100				
0 × 1D	0.3000	0 × 5D	0.9400	0 × 9D	1.5800	0 × DD	2.2200				
0 × 1E	0.3100	0 × 5E	0.9500	0 × 9E	1.5900	0 × DE	2.2300				
0 × 1F	0.3200	0 × 5F	0.9600	0 × 9F	1.6000	0 × DF	2.2400				
0 × 20	0.3300	0 × 60	0.9700	0 × A0	1.6100	0 × E0	2.2500				
0 × 21	0.3400	0 × 61	0.9800	0 × A1	1.6200	0 × E1	2.2600				
0 × 22	0.3500	0 × 62	0.9900	0 × A2	1.6300	0 × E2	2.2700				
0 × 23	0.3600	0 × 63	1.0000	0 × A3	1.6400	0 × E3	2.2800				
0 × 24	0.3700	0 × 64	1.0100	0 × A4	1.6500	0 × E4	2.2900				
0 × 25	0.3800	0 × 65	1.0200	0 × A5	1.6600	0 × E5	2.3000				

# FAN53730

**Table 5. REGISTER DETAILS – 0 × 05 VOUT\_SET\_2 (continued)**

<b>0 × 05 VOUT SET2</b>				<b>Default = 01101000 (1.05 V)</b>							
<b>Bit</b>	<b>Name</b>	<b>Default</b>	<b>Type</b>	<b>Description</b>							
7:0	VSET2	01101000	R/W	Reset conditions: 0 × 68							
				Sets the buck regulation target voltage when VSEL = high.							
				<i>Hex</i>	<i>VOUT(V)</i>	<i>Hex</i>	<i>VOUT(V)</i>	<i>Hex</i>	<i>VOUT(V)</i>	<i>Hex</i>	<i>VOUT(V)</i>
				0 × 26	0.3900	0 × 66	1.0300	0 × A6	1.6700	0 × E6	2.3100
				0 × 27	0.4000	0 × 67	1.0400	0 × A7	1.6800	0 × E7	2.3200
				0 × 28	0.4100	0 × 68	1.0500	0 × A8	1.6900	0 × E8	2.3300
				0 × 29	0.4200	0 × 69	1.0600	0 × A9	1.7000	0 × E9	2.3400
				0 × 2A	0.4300	0 × 6A	1.0700	0 × AA	1.7100	0 × EA	2.3500
				0 × 2B	0.4400	0 × 6B	1.0800	0 × AB	1.7200	0 × EB	2.3600
				0 × 2C	0.4500	0 × 6C	1.0900	0 × AC	1.7300	0 × EC	2.3600
				0 × 2D	0.4600	0 × 6D	1.1000	0 × AD	1.7400	0 × ED	2.3600
				0 × 2E	0.4700	0 × 6E	1.1100	0 × AE	1.7500	0 × EE	2.3600
				0 × 2F	0.4800	0 × 6F	1.1200	0 × AF	1.7600	0 × EF	2.3600
				0 × 30	0.4900	0 × 70	1.1300	0 × B0	1.7700	0 × F0	2.3600
				0 × 31	0.5000	0 × 71	1.1400	0 × B1	1.7800	0 × F1	2.3600
				0 × 32	0.5100	0 × 72	1.1500	0 × B2	1.7900	0 × F2	2.3600
				0 × 33	0.5200	0 × 73	1.1600	0 × B3	1.8000	0 × F3	2.3600
				0 × 34	0.5300	0 × 74	1.1700	0 × B4	1.8100	0 × F4	2.3600
				0 × 35	0.5400	0 × 75	1.1800	0 × B5	1.8200	0 × F5	2.3600
				0 × 36	0.5500	0 × 76	1.1900	0 × B6	1.8300	0 × F6	2.3600
				0 × 37	0.5600	0 × 77	1.2000	0 × B7	1.8400	0 × F7	2.3600
				0 × 38	0.5700	0 × 78	1.2100	0 × B8	1.8500	0 × F8	2.3600
				0 × 39	0.5800	0 × 79	1.2200	0 × B9	1.8600	0 × F9	2.3600
				0 × 3A	0.5900	0 × 7A	1.2300	0 × BA	1.8700	0 × FA	2.3600
				0 × 3B	0.6000	0 × 7B	1.2400	0 × BB	1.8800	0 × FB	2.3600
				0 × 3C	0.6100	0 × 7C	1.2500	0 × BC	1.8900	0 × FC	2.3600
				0 × 3D	0.6200	0 × 7D	1.2600	0 × BD	1.9000	0 × FD	2.3600
				0 × 3E	0.6300	0 × 7E	1.2700	0 × BE	1.9100	0 × FE	2.3600
				0 × 3F	0.6400	0 × 7F	1.2800	0 × BF	1.9200	0 × FF	2.3600

# FAN53730

**Table 6. REGISTER DETAILS – 0 × 06 ENABLE**

<b>0 × 06 ENABLE</b>				<b>Default = 00011000</b>
<b>Bit</b>	<b>Name</b>	<b>Default</b>	<b>Type</b>	<b>Description</b>
7:6	UNUSED			
5	ARM_EN	0	R/W	Reset condition: 0 Audible Reduction Mode Control  <i>Code</i> <i>Audio Reduction Mode Control</i> 0              Audio Reduction Mode Disabled 1              Audio Reduction Mode Enabled
4	DVS_EN	1	R/W	Reset condition: 0 This bit enables/disables the DVS functionality <i>Note:</i> The dvs_en bit only controls whether the part ramps up/down the vout_code in steady state. The part will always ramp up at the programmed DVS ramp during start-up. Additionally, when FCCM is selected the DVS cannot be disabled.  <i>Code</i> <i>DVS Enable</i> 0              DVS disabled 1              DVS enabled
3	OUT_DISCHARGE	1	R/W	Reset condition: 1 Enabled/Disables the 100 Ω output discharge resistance in shutdown  <i>Code</i> <i>Output Discharge Control</i> 0              Output discharge is disabled 1              Output discharge is enabled when device is placed in shutdown
2	VSEL_FCCM	0	R/W	Reset condition: 0 VSEL activates Force CCM  <i>Code</i> <i>VSEL Control FCCM</i> 0              FCCM and VSEL are separate functions 1              FCCM will be enabled when VSEL is at a logic high
1	FORCE_CCM	0	R/W	Reset condition: 0 Forces the part to operate in CCM regardless of the load current  <i>Code</i> <i>Force CCM Control</i> 0              Auto (DCM/CCM depending on load current) 1              Force CCM at all loads
0	ENABLE	0	R/W	Reset condition: 0 This register enables/disables the FAN53730. The EN bit must be set and the EN input must be driven high to enable the device.  <i>Code</i> <i>FAN53730 Enable</i> 0              Device disabled 1              Device enabled

**Table 7. REGISTER DETAILS – 0 × 09 RESET**

<b>0 × 09 RESET</b>				<b>Default = 00000000</b>
<b>Bit</b>	<b>Name</b>	<b>Default</b>	<b>Type</b>	<b>Description</b>
7:0	SOFT_RESET	0	Write	Reset condition: 0 × 00 The software reset register allows all I <sup>2</sup> C settings to be reverted to POR defaults when 0 × 45h code is written to it.

# FAN53730

## APPLICATION CIRCUIT

### Application Circuit Diagram

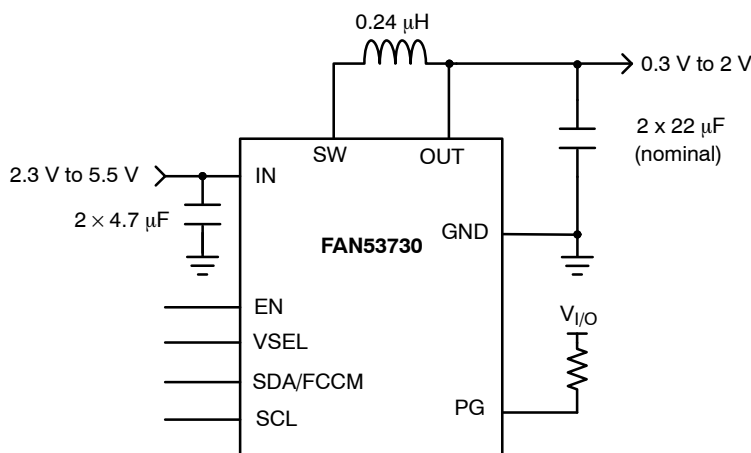

Figure 34. Typical Application Circuit

## APPLICATION GUIDELINES

### Applications Circuit Components

The following table shows the components used in the typical application curves and the System Specifications Table (unless otherwise noted). This table should be used as

a guide in selecting equivalent components from different manufacturers.

### Components Table

#### APPLICATIONS CIRCUIT COMPONENTS EXAMPLES

Component	Manufacturer	Part Number	Value	Case Size (nominal)	Rating	Notes
CIN	Murata	GRM155R61A475MEAA#	4.7 $\mu$ F	1 mm $\times$ 0.5 mm $\times$ 0.5 mm	6.3 V	Local capacitor
COUT	Murata	GRM158R60J226ME01D	22 $\mu$ F	1 mm $\times$ 0.5 mm $\times$ 0.5 mm	6.3 V	Requires 2
L	Taiyo Yuden	LSCNE2012HKTR24MD	0.24 $\mu$ H	2 mm $\times$ 1.25 mm $\times$ 0.8 mm	4.8 A	

### Input Capacitor Consideration

The input current into a buck is discontinuous and can see very fast di/dt ( $> 3$  A/ns). As a result, the input capacitor selection and placement is critical in ensuring the input voltage is clean and the voltage ripple is kept low. A 10  $\mu$ F effective input capacitance can be sufficient to filter the FAN53730's input current, provided that CIN is placed very close to the IN bump and GND bump (see Recommended Layout). If this is not the case then parasitic inductance between (CIN+ and IN), and (CIN - and GND) will create high frequency voltage spikes on the  $V_{IN}$  and GND paths which can feed into  $V_{OUT}$  and other nodes.

Typically two 4.7  $\mu$ F (0402) local capacitors are enough for bypassing IN. However, if CIN is located far away from a low impedance power source (VBATT), any appreciable series inductance between VBATT and CIN can cause a resonance frequency on the IN terminal during load or line transients which can disturb  $V_{OUT}$ . Depending on the

amount of series inductance from VBATT to IN, the CIN capacitance may have to be increased.

### Inductor Consideration

The inductor selection should be based on the required inductor saturation and maximum current rating to support the load current. The Application Circuit Components Table lists the inductor used to generate the typical operating curves, and should be used as a reference for selecting similar inductors for the specific application.

### Output Capacitor Considerations

The FAN53730 is designed to use a minimum (2 x 22  $\mu$ F) nominal output capacitor (or equivalent). COUT should be placed as close as possible to the inductor and the GND bumps. This will minimize any PCB inductance which can cause high frequency conducted noise at the output. The minimum capacitance for stability was based on the typical

## FAN53730

derating curve below (single device). The part number is shown in the Application Circuit Components Table. This nominal curve should be used as a target for selecting suitable capacitors not shown in the Typical Applications Components Table, which are equivalent or better than this.

For capacitors which derate more vs DC bias, it may be necessary to add more in parallel to attain the suitable minimum capacitance.

For  $I_{OUT} < 500$  mA, a single 22  $\mu\text{F}$ (0402) capacitor can be used as long as HIGH\_BANDWIDTH (Reg 02h [1]) = 0.

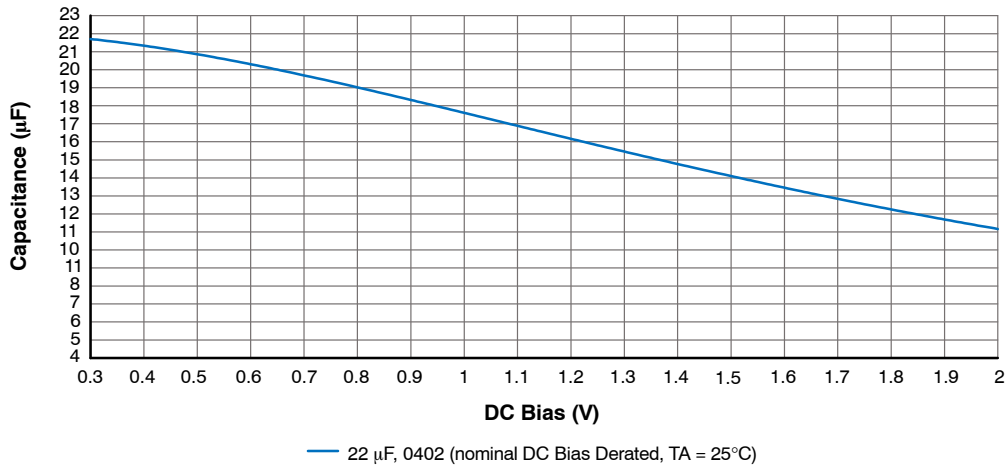

Figure 35. Typical 22  $\mu\text{F}$  Ceramic Capacitor Value vs. DC Bias Voltage

### Layout Examples

The buck converter layout is centered around the placement of CIN, COU, and the inductor L. Because of the discontinuous input current, the placement of CIN is the most critical and should be placed as close to the IN and GND terminals as possible. Secondly, the inductor (L) should be placed close to the COU+ terminal and have a direct connection to SW with minimal PCB trace area.

Minimizing the PCB trace area will limit the parasitic capacitance at SW which can cause a degradation in efficiency. Third, COU(s) should return as close as possible to the inductor and GND connection as possible. The following figure details a layout which can be used as a guideline.

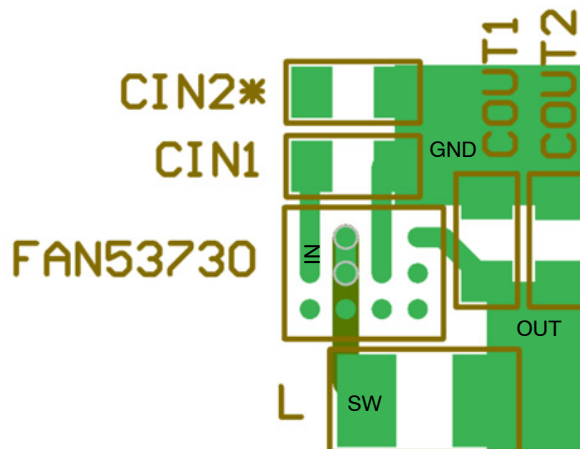
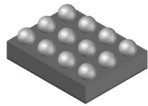

Figure 36. Layout Example

# MECHANICAL CASE OUTLINE PACKAGE DIMENSIONS



**WLCSP12 1.07x1.36x0.432, 0.35P**  
CASE 567GK  
ISSUE O

DATE 09 NOV 2021

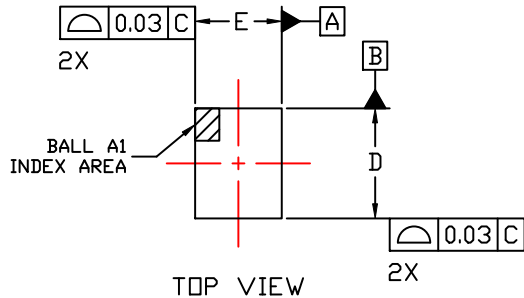

**NOTES:**

1. DIMENSIONING AND TOLERANCING PER ASME Y14.5M, 2009
2. CONTROLLING DIMENSION: MILLIMETERS
3. DATUM C IS DEFINED BY THE SPHERICAL CROWNS OF THE SOLDER BALLS.

DIM	MILLIMETERS		
	MIN.	NOM.	MAX.
A	0.391	0.432	0.473
A1	0.154	0.174	0.194
A2	0.215	0.233	0.251
A3	0.022	0.025	0.028
b	0.211	0.231	0.251
D	1.330	1.360	1.390
E	1.040	1.070	1.100
e	0.35 BSC		
x	0.170	0.185	0.200
y	0.140	0.155	0.170

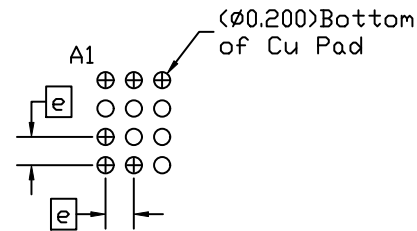
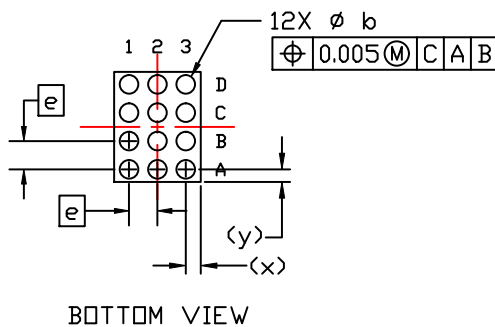
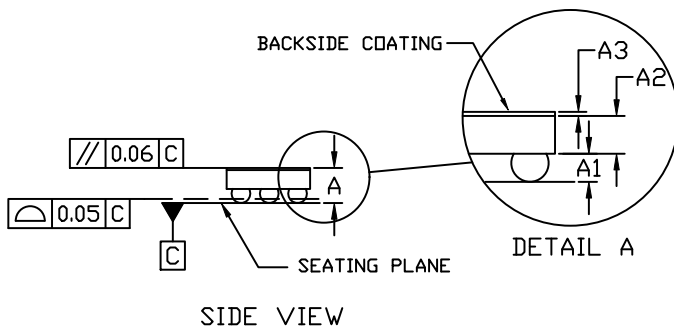

**RECOMMENDED MOUNTING FOOTPRINT\*  
(NSMD PAD TYPE)**

\*FOR ADDITIONAL INFORMATION ON OUR Pb-FREE STRATEGY AND SOLDERING DETAILS, PLEASE DOWNLOAD THE ON SEMICONDUCTOR SOLDERING AND MOUNTING TECHNIQUES REFERENCE MANUAL, SOLDERM/D.

**GENERIC MARKING DIAGRAM\***

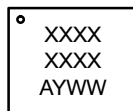

XXXX = Specific Device Code  
A = Assembly Location  
Y = Year  
W = Work Week

\*This information is generic. Please refer to device data sheet for actual part marking. Pb-Free indicator, "G" or microdot "▪", may or may not be present. Some products may not follow the Generic Marking.

<b>DOCUMENT NUMBER:</b>	<b>98AON82480G</b>	Electronic versions are uncontrolled except when accessed directly from the Document Repository. Printed versions are uncontrolled except when stamped "CONTROLLED COPY" in red.
<b>DESCRIPTION:</b>	<b>WLCSP12 1.07x1.36x0.432, 0.35P</b>	<b>PAGE 1 OF 1</b>

onsemi and ONSEMI are trademarks of Semiconductor Components Industries, LLC dba onsemi or its subsidiaries in the United States and/or other countries. onsemi reserves the right to make changes without further notice to any products herein. onsemi makes no warranty, representation or guarantee regarding the suitability of its products for any particular purpose, nor does onsemi assume any liability arising out of the application or use of any product or circuit, and specifically disclaims any and all liability, including without limitation special, consequential or incidental damages. onsemi does not convey any license under its patent rights nor the rights of others.

**onsemi**, **Onsemi**, and other names, marks, and brands are registered and/or common law trademarks of Semiconductor Components Industries, LLC dba "**onsemi**" or its affiliates and/or subsidiaries in the United States and/or other countries. **onsemi** owns the rights to a number of patents, trademarks, copyrights, trade secrets, and other intellectual property. A listing of **onsemi**'s product/patent coverage may be accessed at [www.onsemi.com/site/pdf/Patent-Marking.pdf](http://www.onsemi.com/site/pdf/Patent-Marking.pdf). **onsemi** reserves the right to make changes at any time to any products or information herein, without notice. The information herein is provided "as-is" and **onsemi** makes no warranty, representation or guarantee regarding the accuracy of the information, product features, availability, functionality, or suitability of its products for any particular purpose, nor does **onsemi** assume any liability arising out of the application or use of any product or circuit, and specifically disclaims any and all liability, including without limitation special, consequential or incidental damages. Buyer is responsible for its products and applications using **onsemi** products, including compliance with all laws, regulations and safety requirements or standards, regardless of any support or applications information provided by **onsemi**. "Typical" parameters which may be provided in **onsemi** data sheets and/or specifications can and do vary in different applications and actual performance may vary over time. All operating parameters, including "Typicals" must be validated for each customer application by customer's technical experts. **onsemi** does not convey any license under any of its intellectual property rights nor the rights of others. **onsemi** products are not designed, intended, or authorized for use as a critical component in life support systems or any FDA Class 3 medical devices or medical devices with a same or similar classification in a foreign jurisdiction or any devices intended for implantation in the human body. Should Buyer purchase or use **onsemi** products for any such unintended or unauthorized application, Buyer shall indemnify and hold **onsemi** and its officers, employees, subsidiaries, affiliates, and distributors harmless against all claims, costs, damages, and expenses, and reasonable attorney fees arising out of, directly or indirectly, any claim of personal injury or death associated with such unintended or unauthorized use, even if such claim alleges that **onsemi** was negligent regarding the design or manufacture of the part. **onsemi** is an Equal Opportunity/Affirmative Action Employer. This literature is subject to all applicable copyright laws and is not for resale in any manner.

## ADDITIONAL INFORMATION

### TECHNICAL PUBLICATIONS:

Technical Library: [www.onsemi.com/design/resources/technical-documentation](http://www.onsemi.com/design/resources/technical-documentation)  
onsemi Website: [www.onsemi.com](http://www.onsemi.com)

### ONLINE SUPPORT: [www.onsemi.com/support](http://www.onsemi.com/support)

For additional information, please contact your local Sales Representative at [www.onsemi.com/support/sales](http://www.onsemi.com/support/sales)